

zanilocks

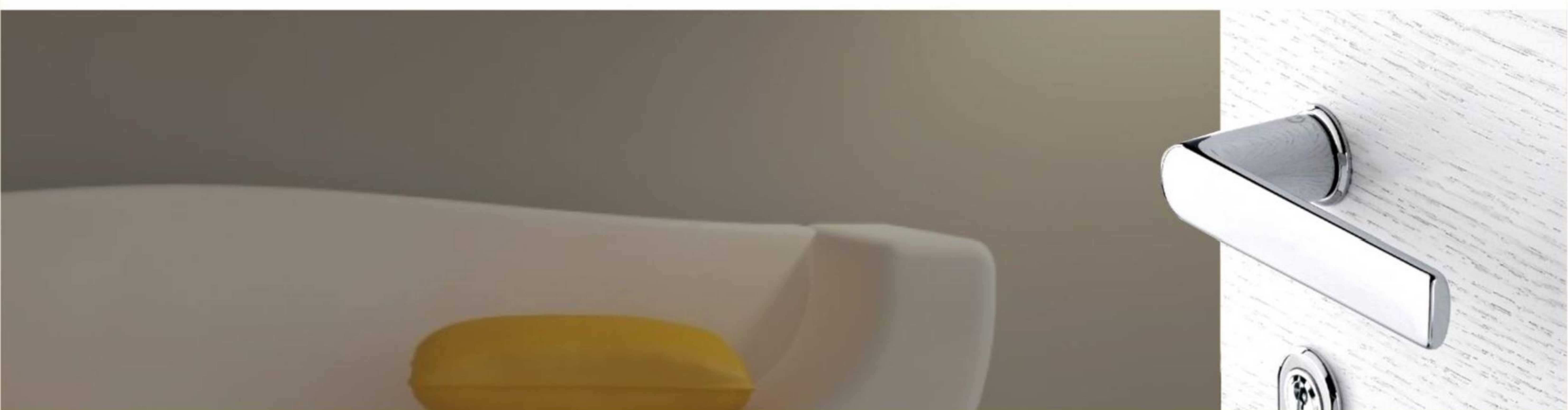

Catalogo Prodotti

SCOPRI LA NOSTRA NUOVA COLLEZIONE

Grazie alla collaborazione di esperti artigiani per la realizzazione di disegni e stampi, ed alla passione tramandata da padre a figlio, l'azienda è una realtà altamente qualificata nella produzione e nella commercializzazione di maniglie ed accessori.

L'affidabilità del processo produttivo, unita alle migliori tecniche e qualitative che si sono succedute nel corso degli anni, rendono il prodotto commercializzato adatto alle più svariate esigenze del cliente.

L'esperienza dei padri e lo spirito innovativo dei figli, uno staff giovane e dinamico, l'attenzione per tutto ciò che è nuovo e moderno ed il rispetto per quello che è classico e tradizione, la qualità del Made In Italy: questi sono oggi i punti di forza che rendono l'azienda attiva nel mercato nel quale spicca per la vendita di prodotti unici e di qualità riconosciuta.

NOVITA' 2016 - NEW ARRIVAL 2016

GAIA



MENFIX



DORICA



GAIA

2410	maniglia c/placca 2150
2412	man. c/ros. PVC
2413	man. c/ros. C.V. 0340
2414	mantellina DRYKEEP

Esecuzione: OLV - OBG - CH - CH/SAT

MENFIX

2180	maniglia c/placca 2190P
2181	maniglia c/ros. 02190
2183	man. c/ros. C.V. 02180
2184	mantellina DRYKEEP

Esecuzione: OLV - OBG - OBGO - OBA - NATURAL

DORICA

2190	maniglia c/placca 2190P
2191	maniglia c/ros. 02190
2193	man. c/ros C.V. 02180
2194	mantellina DRYKEEP

Esecuzione: OBG - OBA - OBGO - NATURAL

INDICE

Maniglie	2 - 52
Maniglie incasso	53
Maniglie sicurezza	54 - 55
Placche	56 - 57
Rosette	58
Maniglioni	59 - 69
Pomoli	70 - 73
Portabiti	74
Battenti	75
Copriavvolgitori	76
Coprinterruttori	77
Fermaporte - Chiavi	78
Catenaccioli - Fermapersiane	
Numeri - Scorrilinghia	79
Corrimano	80 - 81
Bucalettere - Nottolini - Accessori	82
Movimenti	83
Finiture	84
Schemi	85

INDICE ALFABETICO

A	Aisë	2010	22	M	Magnum	2140	31
	At Wien	450	39		Maya	180	47
	Ambra	160	49		Malbù	2890	8
	Apache	440	35		Merino	2710	16
	Arca	410	37		Minerva	2640	18
	Armony	370	24		Mirage	2300	36
	Articoli in polyamide	3010	52		Mitica	300	34
	Articoli in Zama	2980	51		Miura	330	21
	Asia	2100	28		Mix	100	42
	Athena	150	46		Morgana	2480	16
	Aurora	2050	24	N	Nevada	360	29
B	Bahia	2060	26		New Age	2960	49
	Barocco	070	48		Nagara	2150	11
C	Calipso	2320	20		Nilus	2860	30
	Caprice	2110	45	O	Onda	420	37
	Carina	2040	31		Orone	230	43
	Celtica	2230	33	P	Penda	2250	41
	Charme	2910	9		Persia	2620	32
	Cheyenne	2120	27		Peta	430	45
	Classic	2983	50		P'aya	2360	23
D	Daby	140	47		Polaris	2450	43
	Delta	270	14		Prestige	400	26
	Demetra	2340	23		Prisma	2900	8
	Derby	2470	21	Q	Qubik	2840	5
	Diva	290	27	R	Rama	2260	33
E	Elegant	2170	38		Rinascimento	2940	48
	Eisir	2760	15		Rio	2020	42
	Epoca	280	44		Romantica	2970	50
	Erica	120	46		Rugiada	2650	17
	Excalibur	2780	9	S	Safari	2090	40
	Export	220	46		Samarcanda	2950	29
F	Fiji	2870	5		Samoha	2460	6-7
	Florida	2000	13		Selenia	90	47
	Focus	2680	20		Sierra	240	41
	Fox	2930	22		Sveva	2160	19
G	Genesis	310	34	T	Teoria	2380	12
	Ghbil	2770	15		Thema	260	34
	Giada	200	40		Tosca	2430	12
	Ginevra	2720	19		Tuareg	2850	25
	Gloria	2550	17	U	Uovo	390	25
I	Inca	170	47	V	Venixa	2440	10
K	Karisma	2560	32				
L	Lagura	2400	35				
	Lily	320	13				
	Lotus	2210	18				

FIJI



- FIJI**
2870 maniglia c/placca 16P
2873 maniglia c/rosetta 0345
2874 martellina dry keep

Esecuzione: OLV - OBG - OBA
Impugnatura: porcellana champagne

QUBIK



- QUBIK**
2840 maniglia c/placca 16P
2843 maniglia c/rosetta quadrata 0345
2843/B maniglia c/rosetta 0380
2844 martellina dry keep

Esecuzione: CH/SAT - CH - CH-CH/SAT - OLV / OSV

SAMOHA



- SAMOHA**
2460 maniglia c/placca 2230P
2462 maniglia c/rosetta PVC
2463 maniglia c/rosetta 0340
2464 martellina dry keep

Esecuzione: OLV - OBG - OBA - OBGO - OBO
Impugnatura: porcellana bianca - bn
champagne - ch

SAMOHA

SAMOHA

- 2460 maniglia c/placca 2230P
- 2462 maniglia c/rosetta PVC
- 2463 maniglia c/rosetta 0340
- 2464 martellina dry keep

Esecuzione: OLV - OBG - OBA - OBGO - OBO

Impugnature: porcellana champagne decoro A - B - C
champagne dipinto D - E
craquelée F

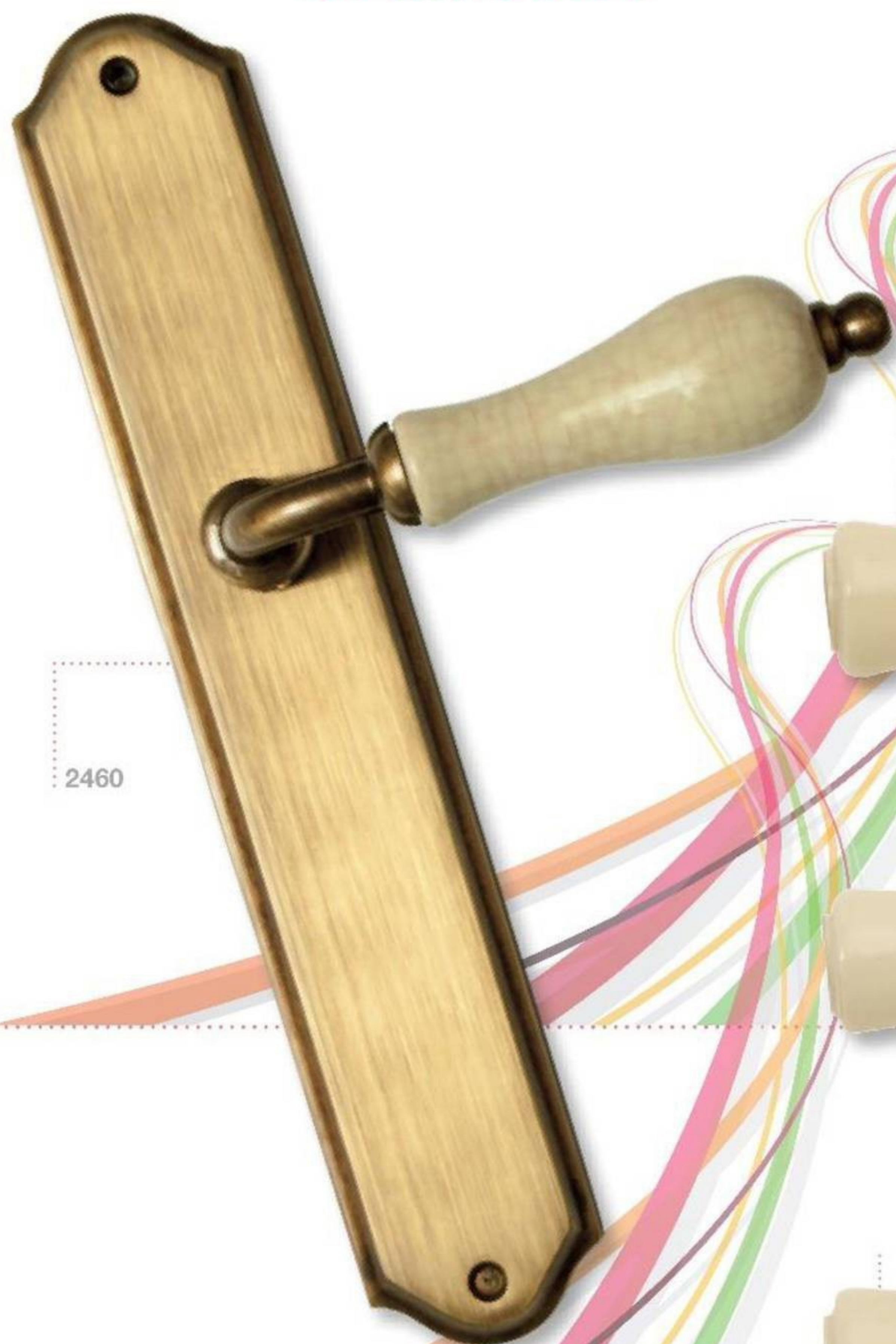

2460



A



D



B



E



C

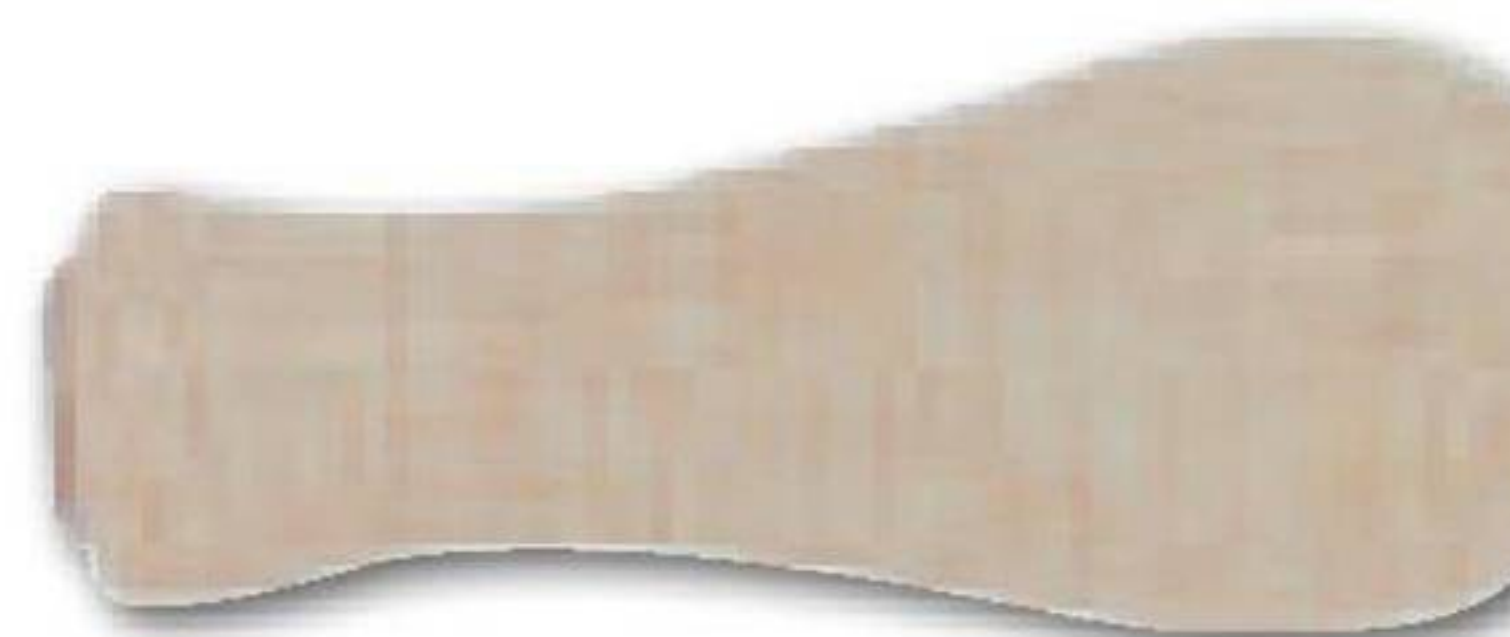

F

PRISMA



2903

MALIBÙ



2893

PRISMA

- 2900 maniglia c/placca 16P
- 2903 maniglia c/rosetta 0345
- 2904 martellina dry keep

Esecuzione: OLV - CH - CH/SAT - OBA

MALIBÙ

- 2890 maniglia c/placca 16P
- 2893 maniglia c/rosetta 0345
- 2894 martellina dry keep

Esecuzione: OLV/OSV - CH-CH/SAT - NI-NI/SAT

EXCALIBUR



EXCALIBUR

- 2780 maniglia c/placca 2060P
- 2783 maniglia c/rosetta 0340
- 2784 martellina dry keep

Esecuzione: OLV/OBG - OLV/OSV - CH-CH/SAT

CHARME



CHARME

- 2910 maniglia c/placca 2060P
- 2913 maniglia c/rosetta 0340
- 2913/B maniglia c/rosetta 0345
- 2914 martellina dry keep
- 2920 maniglia c/puntini c/placca 16P
- 2923 maniglia c/rosetta 0340 c/puntini
- 2923/B maniglia c/rosetta 0345 c/puntini
- 2924 martellina dry keep

Esecuzione: OLV/OS - CH-CH/SAT - CH - ACCIAIO

VENIXIA



VENIXIA

- 2440 maniglia c/placca 200P
- 2442 maniglia c/rosetta PVC
- 2443 maniglia c/rosetta 0340
- 2444 martellina dry keep
- 2445 cremonese
- 2446 martellina

Esecuzione: OLV - OBG - CH/SAT - CH - NI/SAT

NIAGARA



NIAGARA

2150	maniglia c/placca 2150P	g. 770
2152	maniglia c/rosetta coprivite PVC	g. 580
2153	maniglia c/rosetta coprivite 0340	
2154	martellina dry keep	
2155	cremonese	
2156	martellina	g. 327
2157	maniglia c/rosetta coprivite ovale PVC	

Esecuzione: OLV - OBG - CH/SAT - CH - NI/SAT - PVD



TEORIA



TEORIA

2380	maniglia c/placca 270P
2383	maniglia c/rosetta 0340
2384	martellina dry keep

Esecuzione: OLV - CH/SAT - NI/SAT - CH

TOSCA

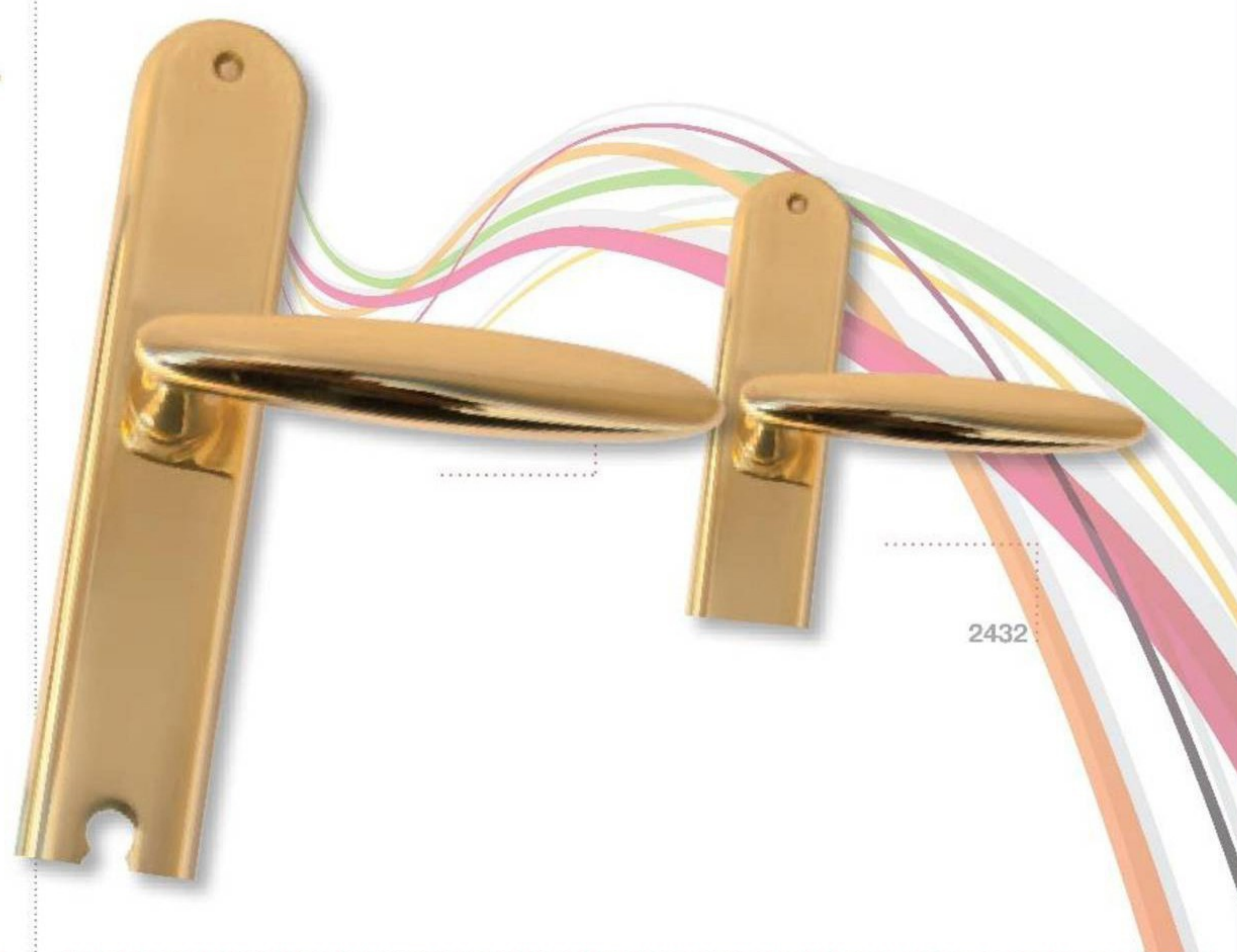

TOSCA

2430	maniglia c/placca 2150P
2432	maniglia c/rosetta PVC
2433	maniglia c/rosetta 0340
2434	martellina dry keep

Esecuzione: OLV - OBG - CH/SAT - CH - NI/SAT

LILLY



LILLY

320	maniglia c/placca 200P	g. 800
322	maniglia c/rosetta coprivite PVC	g. 585
323	maniglia c/rosetta coprivite 0340	g. 785
324	martellina dry keep	
325	cremonese	
326	martellina	

Esecuzione: OLV - OBG - CH/SAT

FLORIDA



FLORIDA

2000	maniglia c/placca 270P	g. 950
2003	maniglia c/rosetta 0340	g. 880
2004	martellina dry keep	
2005	cremonese	
2006	martellina	g. 360

Esecuzione: OLV - OBG - CH/SAT - -CH - NI/SAT

DELTA



DELTA

270	maniglia c/placca 270P	g. 975
271	maniglia c/rosetta 0200	
273	maniglia c/rosetta 0340	g. 905
274	martellina dry keep	
275	cremonese	
276	martellina	g. 370

Esecuzione: OLV - OBG - OLS - CH/SAT

ELISIR



ELISIR

- 2760 maniglia c/placca 206OP
- 2763 maniglia c/rosetta 0340
- 2764 martellina dry keep

Esecuzione: OLV/OSV - OLV/OBG - CH-CH/SAT

GHIBLI



GHIBLI

- 2770 maniglia c/placca 206OP
- 2773 maniglia c/rosetta 0340
- 2774 martellina dry keep

Esecuzione: OLV/OS - OLV/OBG - CH-CH/SAT

MERLINO



MERLINO

- 2710 maniglia c/placca 206OP
- 2713 maniglia c/rosetta 0340
- 2714 martellina dry keep

Esecuzione: OLV/OS - OLV/OBG - CH-CH/SAT - PALISSANDRO

MORGANA



MORGANA

- 2480 maniglia c/placca 206OP
- 2483 maniglia c/rosetta 0340
- 2484 martellina dry keep

Esecuzione: OLV/OBG - OLV/OS - CH-CH/SAT - OLV/P - OLV/RO
PALISSANDRO - ROVERE

GLORIA



GLORIA

- 2550 maniglia c/placca 206OP
- 2553 maniglia c/rosetta 0340
- 2554 martellina dry keep

*Esecuzione: OLV/OS - OLV - OBG/OLV - CH-CH/SAT
RADICA - PALISSANDRO*

RUGIADA



RUGIADA

- 2650 maniglia c/placca 206OP
- 2653 maniglia c/rosetta 0340
- 2654 martellina dry keep

Esecuzione: OLV/OS - OLV/OBG - CH-CH/SAT

MINERVA



MINERVA

- 2640 maniglia c/placca 206OP
- 2642 maniglia c/rosetta PVC
- 2643 maniglia c/rosetta 0340
- 2644 martellina dry keep

Esecuzione: OLV/OS - OLV/OBG - CH-CH/SAT

LOTUS



LOTUS

- 2210 maniglia c/placca 206OP
- 2212 maniglia c/rosetta PVC
- 2213 maniglia c/rosetta 0340
- 2214 martellina dry keep

Esecuzione: OLV/OS - OLV/OBG - CH-CH/SAT - CH-NI/SAT - CH/INOX

SVEVA



SVEVA

2160	maniglia c/placca 200P	g. 860
2162	maniglia c/rosetta PVC	g. 655
2163	maniglia c/rosetta coprivite 0340	
2164	martellina dry keep	
2165	cremonese	
2166	martellina	g. 375

Esecuzione: OLV - OBG - CH/SAT - CH - NI/SAT

GINEVRA



GINEVRA

2720	maniglia c/placca 200P	g. 800
2722	maniglia c/rosetta PVC	g. 585
2723	maniglia c/rosetta 0340	g. 785
2724	martellina dry keep	

Esecuzione: OLV/OS - CH-CH/SAT

FOCUS



FOCUS

2680	maniglia c/placca 200P	g. 800
2683	maniglia c/rosetta 0340	g. 785
2684	martellina dry keep	

Esecuzione: OLV/OS - CH-CH/SAT - CH-NI/SAT - CH/INOX

CALIPSO



CALIPSO

2320	maniglia c/placca 60P	g. 800
2323	maniglia c/rosetta coprivite	g. 785
2324	martellina dry keep	

Esecuzione: OLV/OS - OLV/OBG - CH-CH/SAT

DERBY



DERBY

2470	maniglia c/placca 2060P	g. 800
2473	maniglia c/rosetta 0340	g. 785
2474	martellina dry keep	

Esecuzione: OLV/OS - OLV - OBG/OLV - CH-CH/SAT

MIURA



MIURA

330	maniglia c/placca 270P	g. 1030
332	maniglia c/rosetta PVC	g. 960
333	maniglia c/rosetta 0340	g. 960
334	martellina dry keep	
335	cremonese	
336	martellina	g. 426

Esecuzione: OLV - OBG - CH-SAT

ALISÈ



ALISÈ

2010	maniglia c/placca 270P	g. 1020
2013	maniglia c/rosetta coprivate 0340	g. 960
2014	martellina dry keep	

Esecuzione: OBG - OLV - CH-SAT

FOX



FOX

2930	maniglia c/placca 270P	g. 1020
2933	maniglia c/rosetta 0340	g. 960
2934	martellina dry keep	

Esecuzione: OLV/OSV - CH/CHSAT

DEMETRA



DEMETRA

- 2340 maniglia c/placca 2230/P
- 2343 maniglia c/rosetta 0340
- 2344 martellina dry keep

Esecuzione: OLV - OBG - AGA - OBA - OBGO

PLAYA



PLAYA

- 2360 maniglia c/placca 2230P
- 2363 maniglia c/rosetta 0340
- 2364 martellina dry keep

Esecuzione: OLV - OBA - OBG - OBGO

ARMONY



ARMONY

- | | | |
|-----|-------------------------|---------|
| 370 | maniglia c/placca 370P | g. 1000 |
| 373 | maniglia c/rosetta 0340 | g. 910 |
| 374 | martellina dry keep | |
| 375 | cremonese | |
| 376 | martellina | g. 390 |

Esecuzione: OLV - OBG - CH/SAT

AURORA

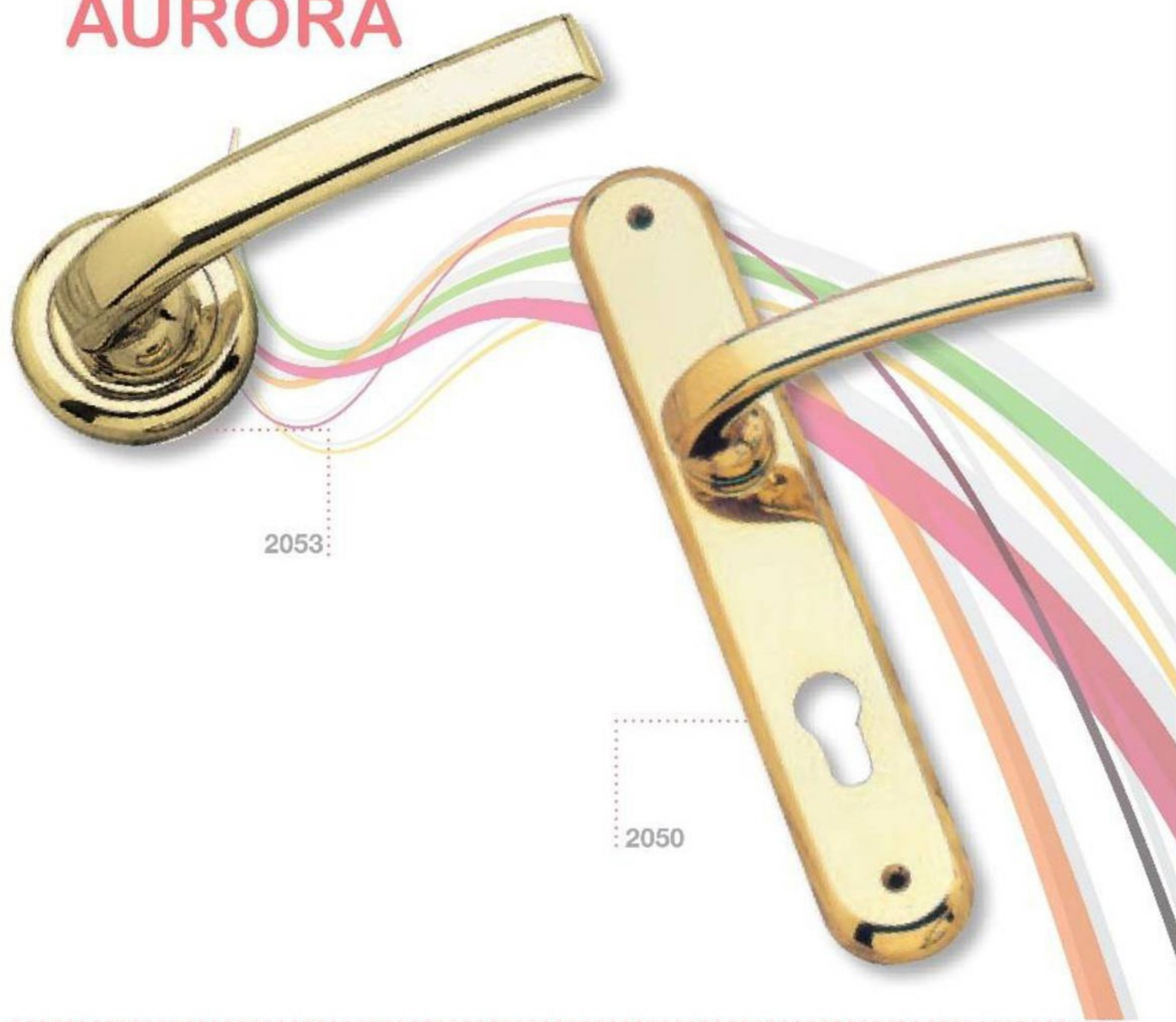

AURORA

- | | | |
|------|-------------------------|--------|
| 2050 | maniglia c/placca 270P | g. 910 |
| 2053 | maniglia c/rosetta 0340 | g. 850 |
| 2054 | martellina dry keep | |
| 2055 | cremonese | |
| 2056 | martellina | g. 360 |

Esecuzione: OLV - CH/SAT - CH

TUAREG



TUAREG

- 2850 maniglia c/placca 2230
- 2852 maniglia c/rosetta PVC
- 2853 maniglia c/rosetta 0340
- 2854 martellina dry keep

Esecuzione: OLV - OBA - OBO - OBGO - OBG

UOVO



UOVO

- 390 maniglia c/placca 270
- 392 maniglia c/rosetta PVC
- 393 maniglia c/rosetta 0340

Esecuzione: OLV - OBG - CH-CH/SAT

BAHIA



BAHIA

- | | | | |
|------|-------------------------|----|-----|
| 2060 | maniglia c/placca 2060P | g. | 940 |
| 2063 | maniglia c/rosetta 0340 | g. | 940 |
| 2064 | martellina dry keep | | |
| 2065 | cremonese | | |
| 2066 | martellina | g. | 360 |

Esecuzione: OLV - CH-CH/SAT

PRESTIGE



PRESTIGE

- | | | | |
|-----|-------------------------|----|-----|
| 400 | maniglia c/placca 370P | g. | 950 |
| 403 | maniglia c/rosetta 0340 | g. | 860 |
| 404 | martellina dry keep | | |
| 405 | cremonese | | |
| 406 | martellina | g. | 380 |

Esecuzione: OLV - OBG - CH-SAT

DIVA



DIVA

- 290 maniglia c/placca 270P
- 291 maniglia c/rosetta 0200
- 293 maniglia c/rosetta 0340
- 294 martellina dry keep
- 295 cremonese
- 296 martellina

Esecuzione: OLS - OBG

CHEYENNE



CHEYENNE

- 2120 maniglia c/placca 2100/P
- 2123 maniglia c/rosetta 0340
- 2124 martellina dry keep

g. 880
g. 860

Esecuzione: OLV - OBA - OBGO - OBO

ASIA

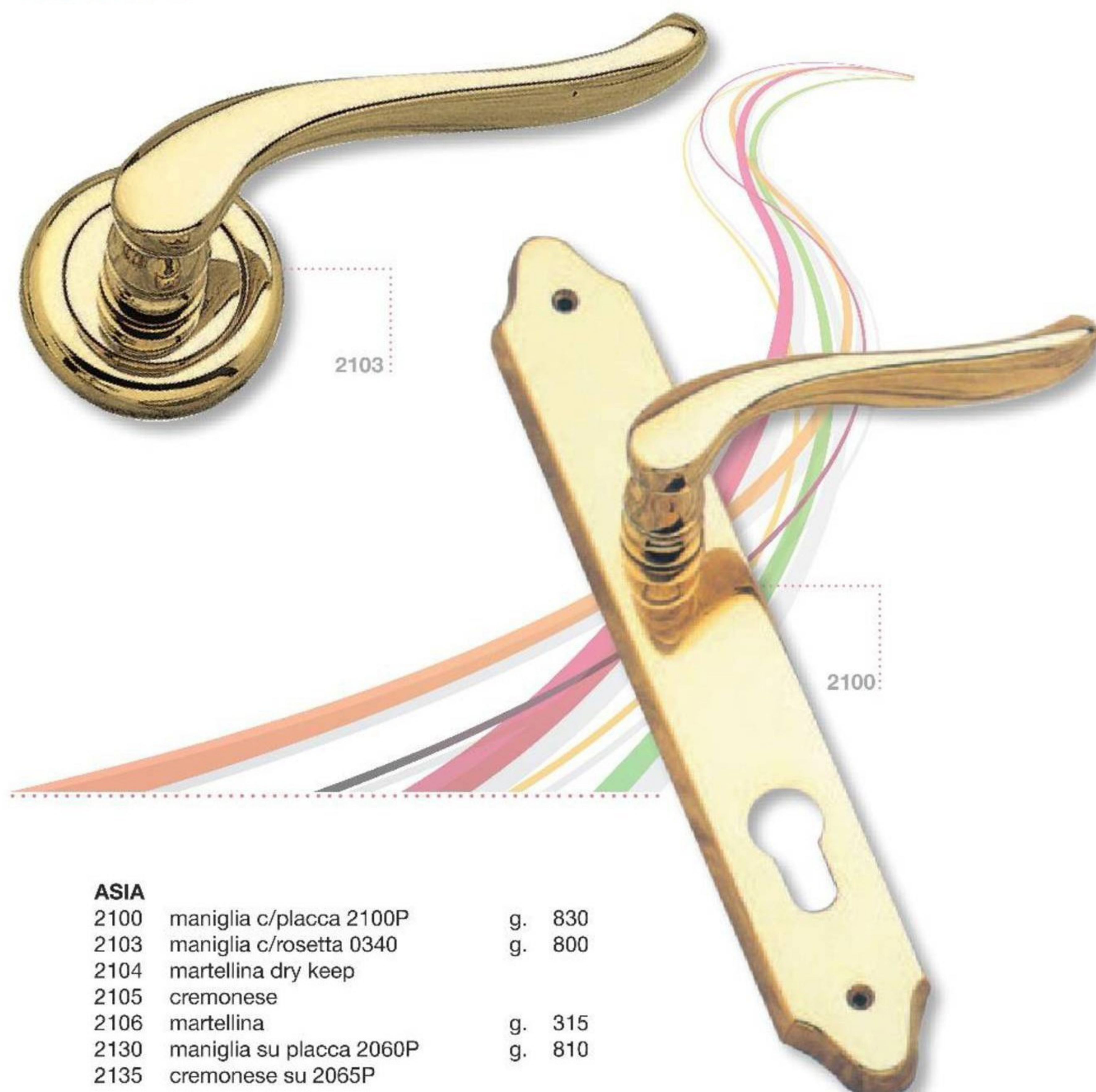

ASIA

- 2100 maniglia c/placca 2100P g. 830
- 2103 maniglia c/rosetta 0340 g. 800
- 2104 martellina dry keep
- 2105 cremonese
- 2106 martellina g. 315
- 2130 maniglia su placca 2060P g. 810
- 2135 cremonese su 2065P

Esecuzione: OLV - OBG - OBGO - OBA - CH

NEVADA



NEVADA

360	maniglia c/placca 270P	g. 904
361	maniglia c/rosetta 0200	g. 715
363	maniglia c/rosetta 0340	g. 835
364	martellina dry keep	
365	cremonese	
366	martellina	g. 320

Esecuzione: OLV - OBS - CH-SAT

SAMARCANDA



SAMARCANDA

2950	maniglia c/placca 2060/P
2953	maniglia c/rosetta
2954	martellina dry keep

Esecuzione: OLV/OSV - CH/CH-SAT

NILUS



NILUS

2860	maniglia c/placca 270/P
2862	maniglia c/rosetta PVC
2863	maniglia c/rosetta 0340
2864	martellina dry keep

Esecuzione: OBG - OLV - CH/SAT - NI/SAT - OBGO

CARINA

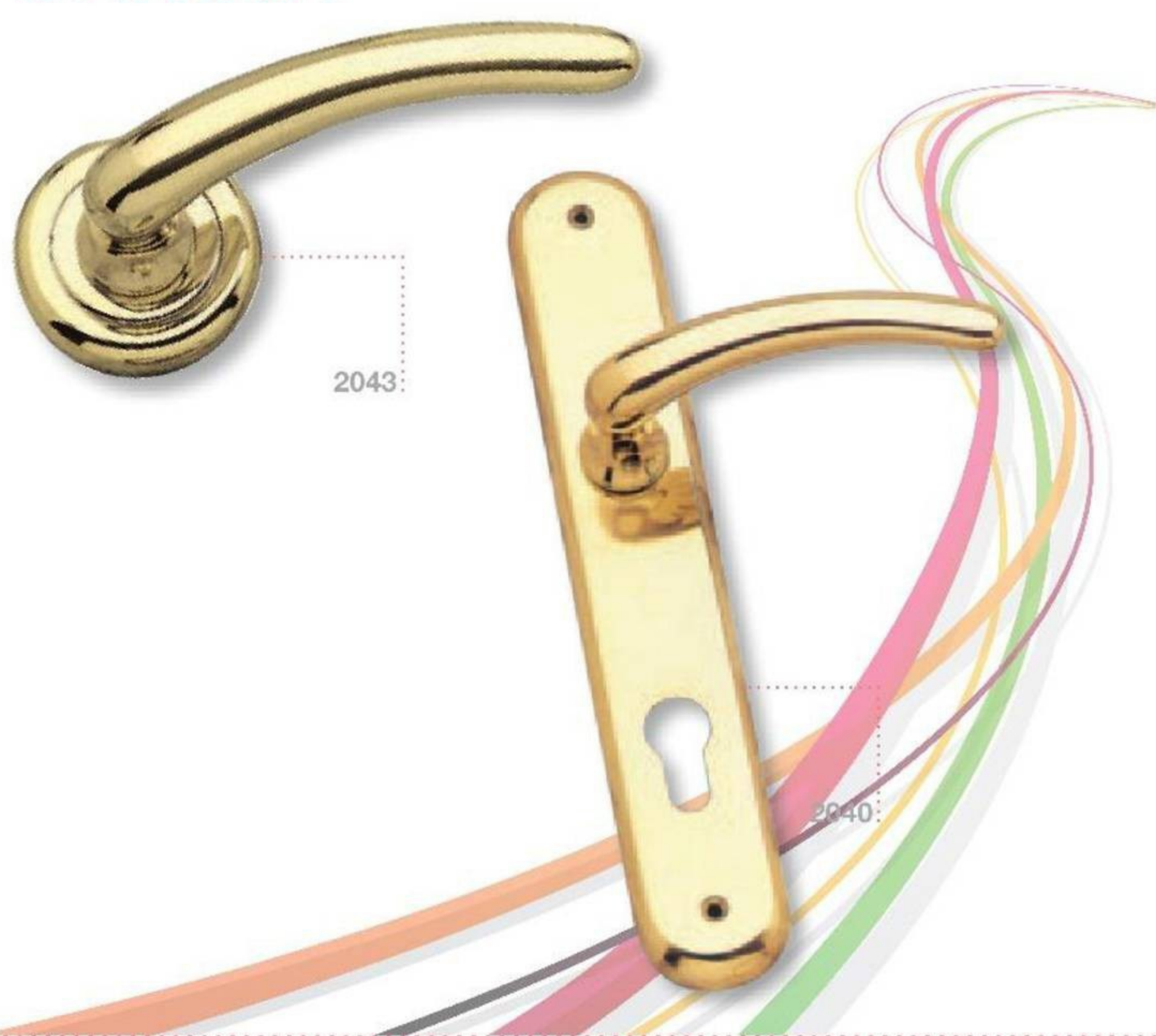

CARINA

2040	maniglia c/placca 270/P	g. 915
2043	maniglia c/rosetta 0340	g. 855
2044	martellina dry keep	
2045	cremonese	
2046	martellina	g. 362

Esecuzione: OLV - OBG - CH/SAT - CH

MAGNUM



MAGNUM

2140	maniglia c/placca 2140/P	g. 1230
2143	maniglia c/rosetta 0340	
2144	martellina dry keep	

Esecuzione: OLV - OBG - CH/SAT

KARISMA

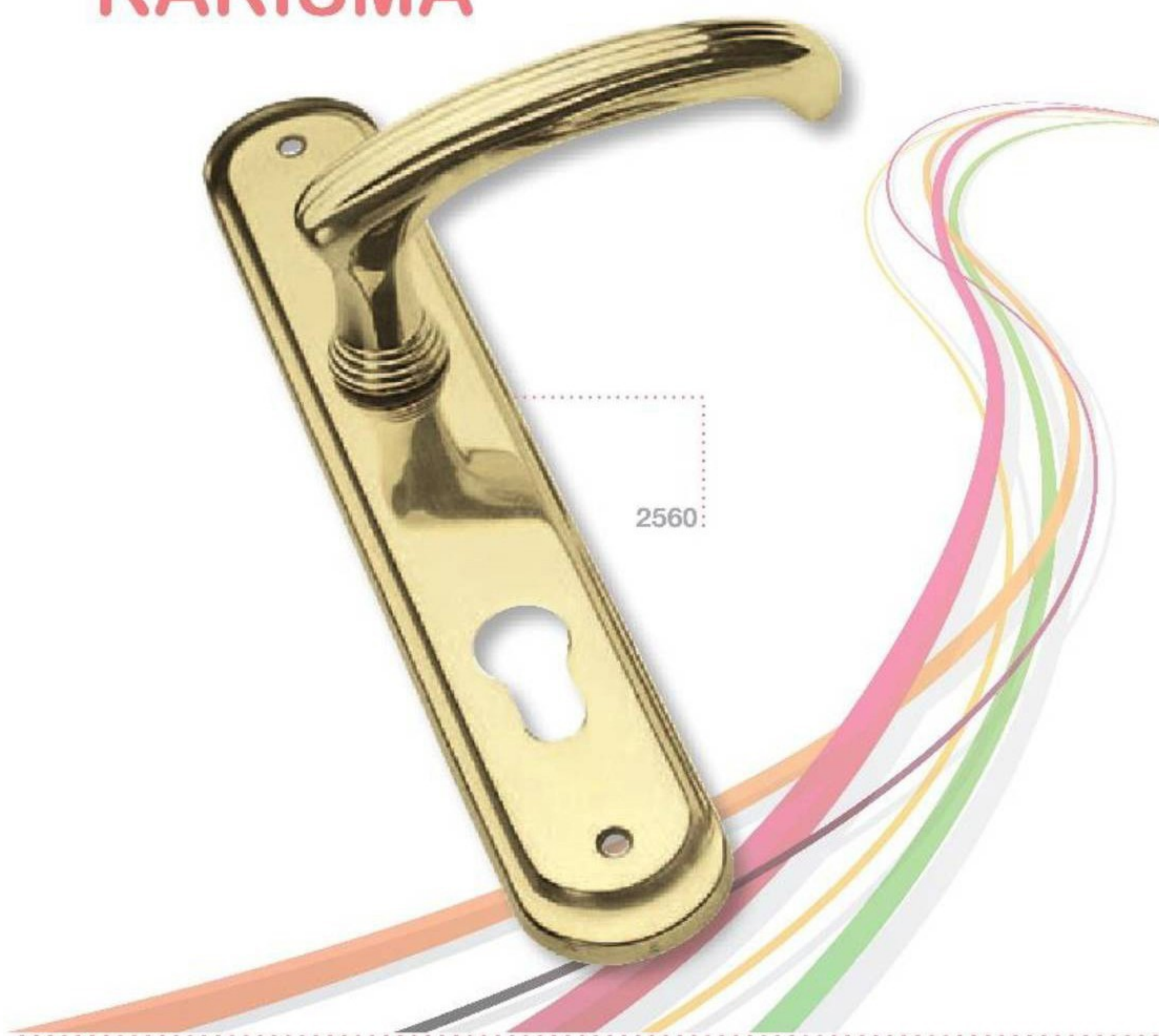

KARISMA

2560	maniglia c/placca 2060/P
2560/B	maniglia c/placca 2140/P
2563	maniglia c/rosetta 0340
2564	martellina dry keep

Esecuzione: OLV - OBG

PERSIA



PERSIA

2620	maniglia c/placca 2704/P
2623	maniglia c/rosetta 0340
2624	martellina dry keep

Esecuzione: OLV/IOS - OLV/OBG - CH/CH-SAT - OLV/ANTH

RAMA

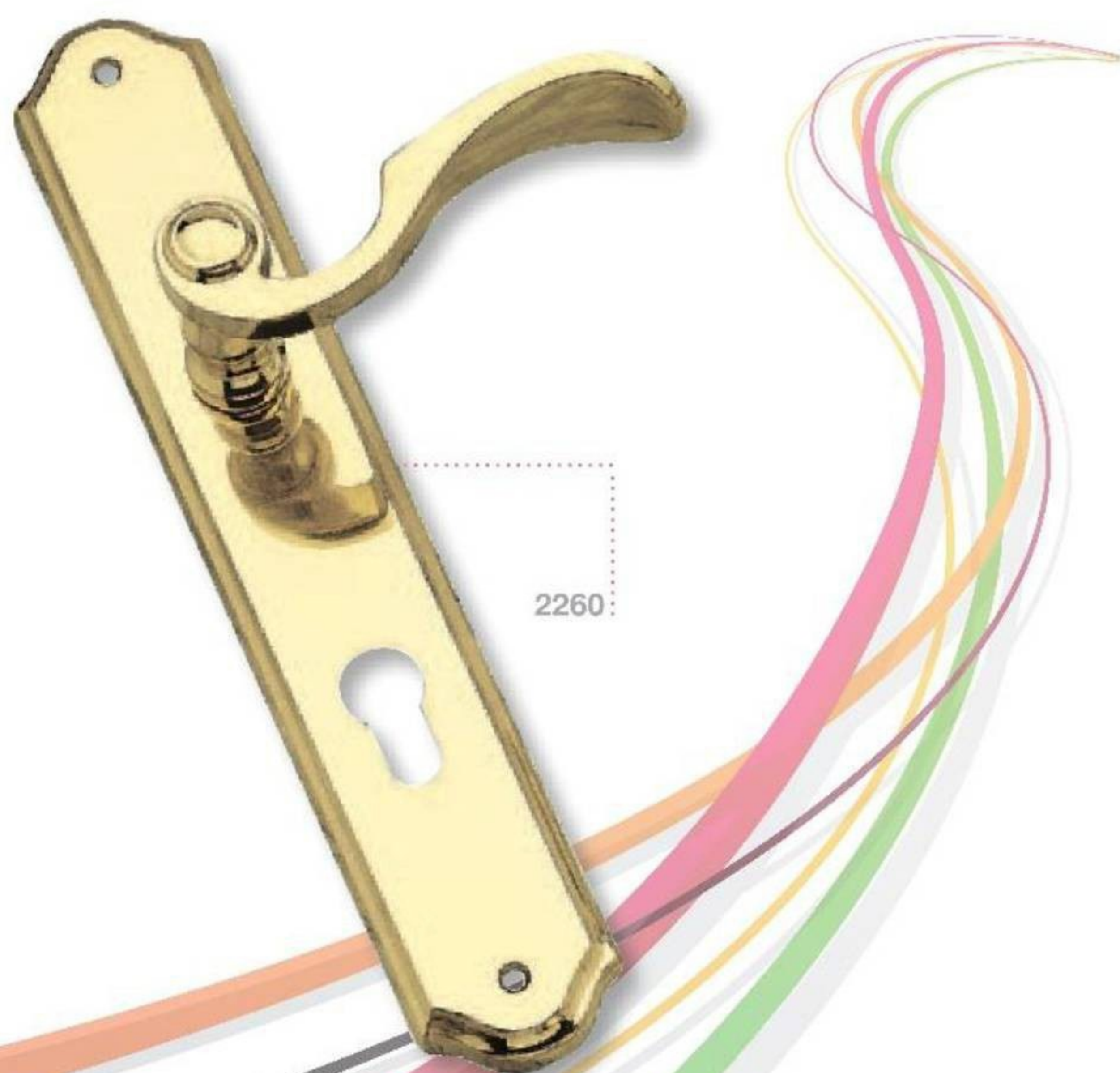

- RAMA**
 2260 maniglia c/placca 2230/P
 2263 maniglia c/rosetta 0340
 2264 martellina dry keep

Esecuzione: OLV - CH-CH/SAT

CELTICA



- CELTICA**
 2230 maniglia c/placca 2230/P
 2233 maniglia c/rosetta 0340 g. 920
 2234 martellina dry keep g. 820

Esecuzione: OLV - OBG - CH-CH/SAT

MITICA



- MITICA**
 300 maniglia c/placca g. 935
 303 maniglia c/rosetta coprivite g. 860
 304 martellina dry keep
 305 cremonese
 306 martellina g. 360

Esecuzione: OLS - OBS

THEMA



- THEMA**
 260 maniglia c/placca 300P g. 790
 263 maniglia c/rosetta 0340 g. 780
 264 martellina dry keep
 265 cremonese
 266 martellina g. 335

Esecuzione: OLS - OBS

GENESI

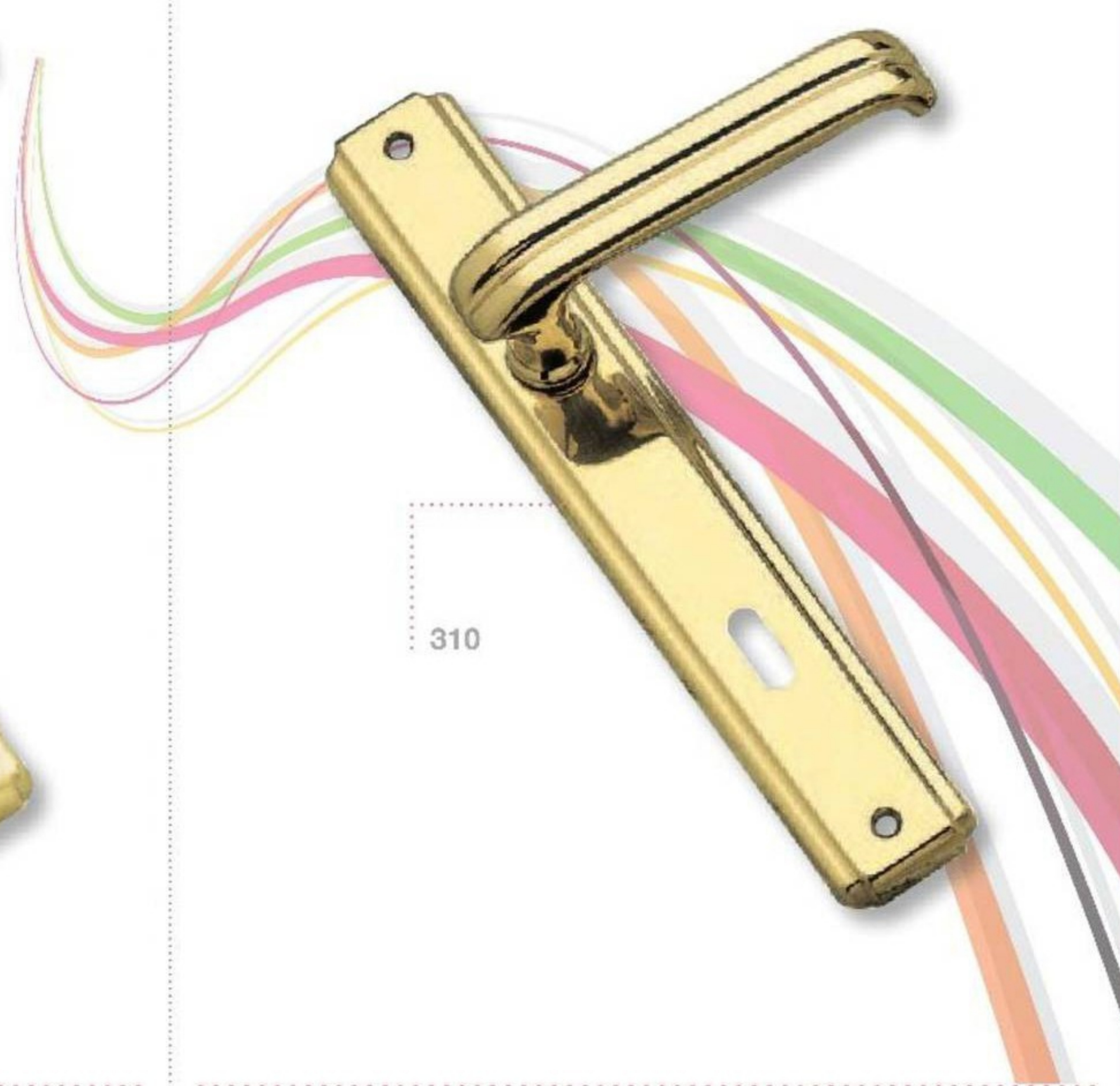

- GENESI**
 310 maniglia c/placca 300P g. 970
 313 maniglia c/rosetta 0340
 314 martellina dry keep
 315 cremonese
 316 martellina g. 375

Esecuzione: OLV - OBG

APACHE



APACHE

440	maniglia c/placca 270P	g. 950
443	maniglia c/rosetta 0340	g. 880
444	martellina dry keep	
445	cremonese	
446	martellina	g. 330

Esecuzione: OLV - CH/SAT - NI/SAT

LAGUNA

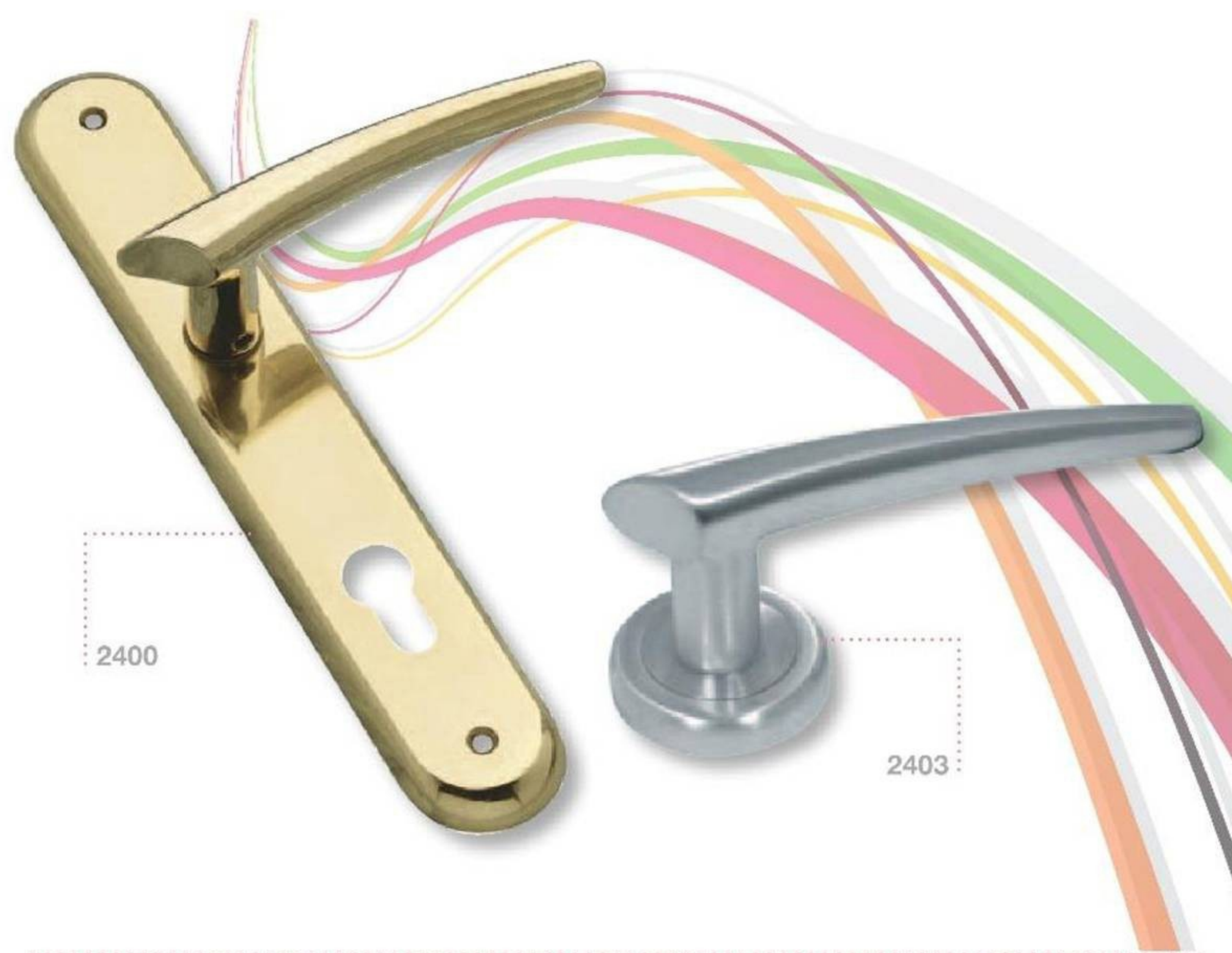

LAGUNA

2400	maniglia c/placca 270
2403	maniglia c/rosetta 0340
2404	martellina dry keep

Esecuzione: OLV - CH - CH/SAT - OSV

MIRAGE



MIRAGE

2300	maniglia c/placca 2060P
2303	maniglia c/rosetta coprivite
2304	martellina dry keep
2305	cremonese
2306	martellina
2300M/2140P	maniglia c/placca 2140P

Esecuzione: OLV - CH - CH/SAT - OSV

ONDA



ONDA

420	maniglia c/placca 2M 200P	g. 670
421	maniglia c/rosetta 0200	g. 520
422	maniglia c/rosetta PVC	
423	maniglia c/rosetta 0340	
424	martellina dry keep	g. 365
425	cremonese	
426	martellina	
2080	maniglia Onda su pl. 270p	

Esecuzione: OLV - OBG - CH/SAT - CH

ARCA

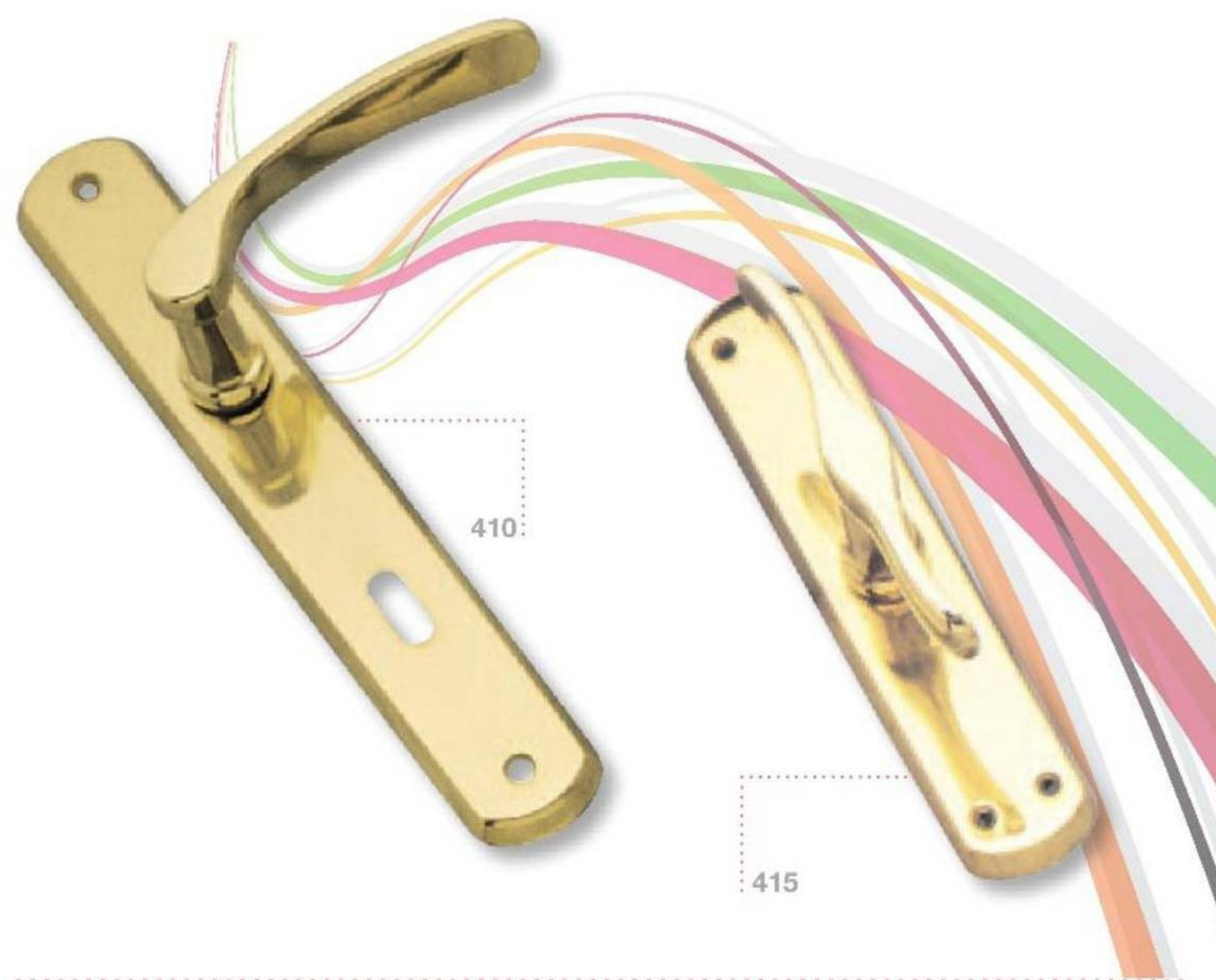

ARCA

410	maniglia c/placca 2M 170P	g. 604
411	maniglia c/rosetta 0200	g. 520
412	maniglia c/rosetta PVC	
414	martellina dry keep	
415	cremonese	
416	martellina	g. 275

Esecuzione: OLV - OBG - CH/SAT - CH

ELEGANT



ELEGANT

2170	maniglia c/placca 2150P	g. 690
2171	maniglia c/rosetta 0200	
2172	maniglia c/rosetta PVC	g. 835
2173	maniglia c/rosetta 0340	
2174	martellina dry keep	



2175	cremonese	
2176	martellina	g. 220
2176/B	martellina su rosetta 02179F	
2179	mini-segretino (62x33)	g. 85

Esecuzione: OLV - OBG - OBA - CH - CH-SAT - NI/SAT

ALT WIEN



ALT WIEN

450	maniglia c/placca 450P	g. 740
452	maniglia c/450P copriforo	
453	maniglia c/rosetta 0340	g. 780
454	maniglia DK	
455	cremonese	
456	martellina	g. 335
456/b	martellina c/rosetta 0419F	
459	mignon c/rosetta (64x34)	g. 105

Esecuzione: OLV - OBA - CH - OBG - CHSAT - NISAT

GIADA



GIADA

200	maniglia c/placca 200P 2M	g. 740
201	maniglia c/rosetta 0200	g. 570
204	martellina dry keep	
205	cremonese	
206	martellina	g. 345

Esecuzione: OLS - OBG

SAFARI



SAFARI

2090	maniglia c/placca 200P	g. 795
2091	maniglia c/rosetta 0200	
2092	maniglia c/rosetta PVC	g. 575
2093	maniglia c/rosetta coprivate 0340	g. 775
2094	martellina dry keep	
2095	cremonese	
2096	martellina	g. 365

Esecuzione: OLV - OBG

SIERRA



SIERRA

- 240 maniglia c/placca 200P
- 240/B maniglia c/placca 2230P
- 241 maniglia c/rosetta 0200
- 243 maniglia c/rosetta 0340
- 244 martellina dry keep
- 245 cremonese
- 246 martellina

Esecuzione: OLV - OBG - OBCO

PENDA

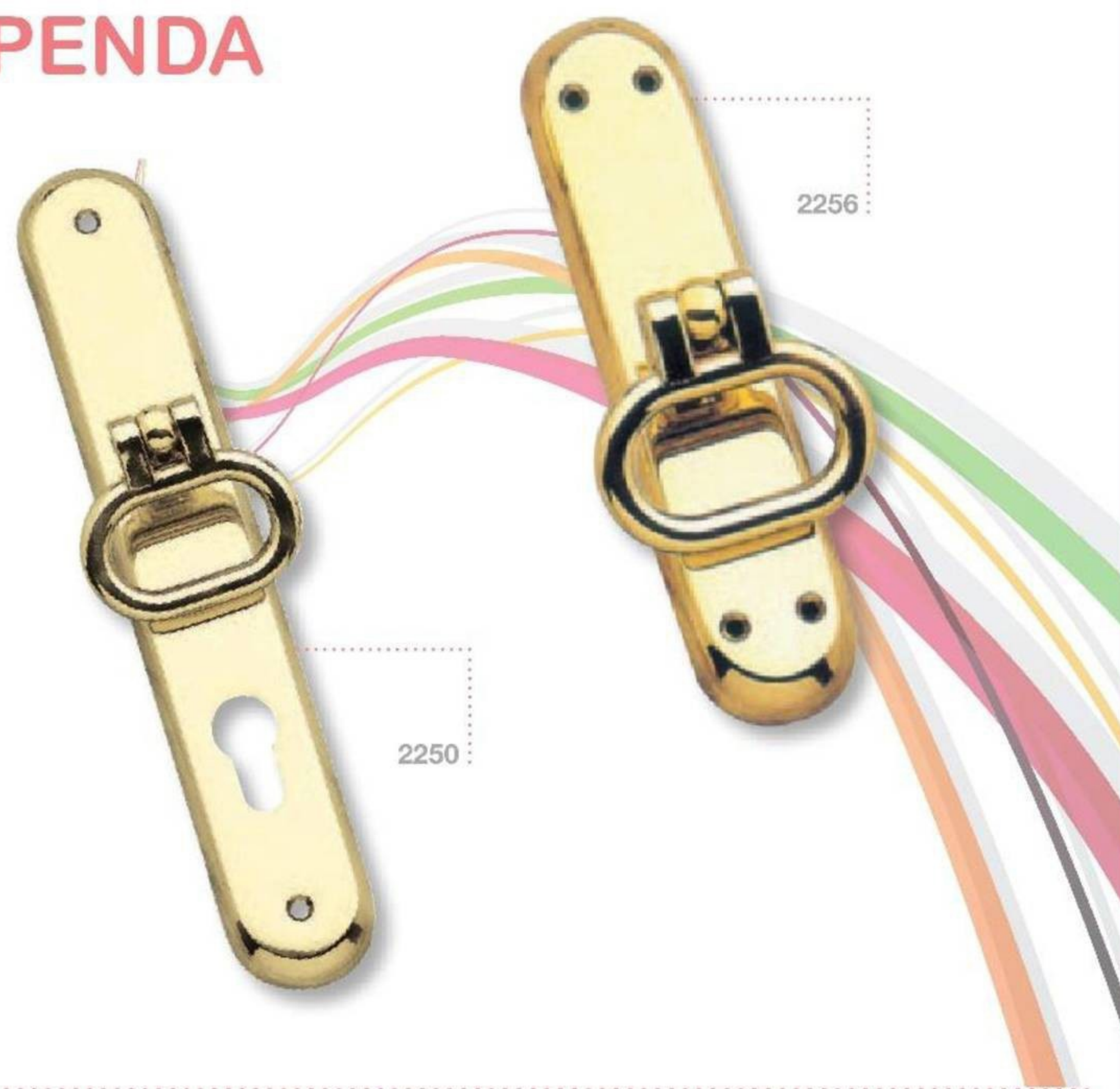

PENDA

- 2250 maniglia c/placca 270/P
- 2252 maniglia c/rosetta PVC
- 2256 martellina
- 2255 cremonese

Esecuzione: OLV - OBG - CH/SAT

RIO



RIO

- | | | |
|------|----------------------------------|--------|
| 2020 | maniglia c/placca | g. 572 |
| 2021 | maniglia c/rosetta ovale | g. 488 |
| 2022 | maniglia c/rosetta coprivite PVC | |
| 2024 | martellina dry keep | |
| 2025 | cremonese | |
| 2026 | martellina | g. 270 |

Esecuzione: OLV - OBG - NI/SAT - CH/SAT

MIX



MIX

- | | | |
|-----|-------------------------|--------|
| 100 | maniglia c/placca 170P | g. 590 |
| 101 | maniglia c/rosetta 0200 | g. 510 |
| 102 | maniglia c/rosetta PVC | |
| 104 | martellina DK | |
| 105 | cremonese | |
| 106 | martellina | g. 275 |

Esecuzione: OLV - OBS

POLARIS

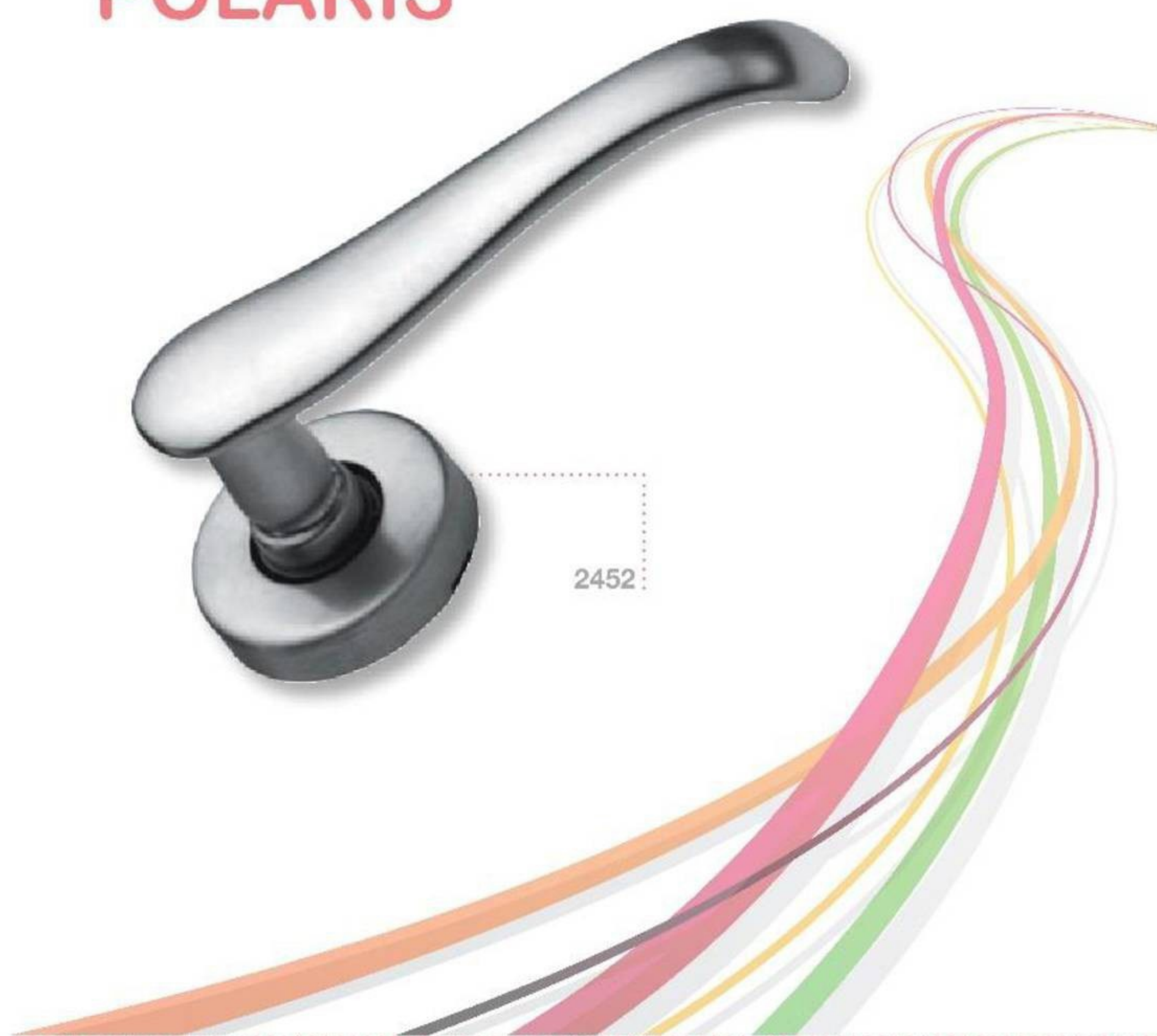

POLARIS

- 2450 maniglia c/placca 2150/P
- 2452 maniglia c/rosetta PVC
- 2454 martellina DK
- 2455 cremonese
- 2456 martellina

Esecuzione: OLV - OBG - CH/SAT - CH

ORIONE



ORIONE

- 230 maniglia c/placca 200P g. 890
- 231 maniglia c/rosetta 0200
- 233 maniglia c/rosetta 0340 g. 875
- 234 martellina dry keep
- 235 cremonese
- 236 martellina g. 355

Esecuzione: OLV - OBG - CH/SAT - CH

EPOCA

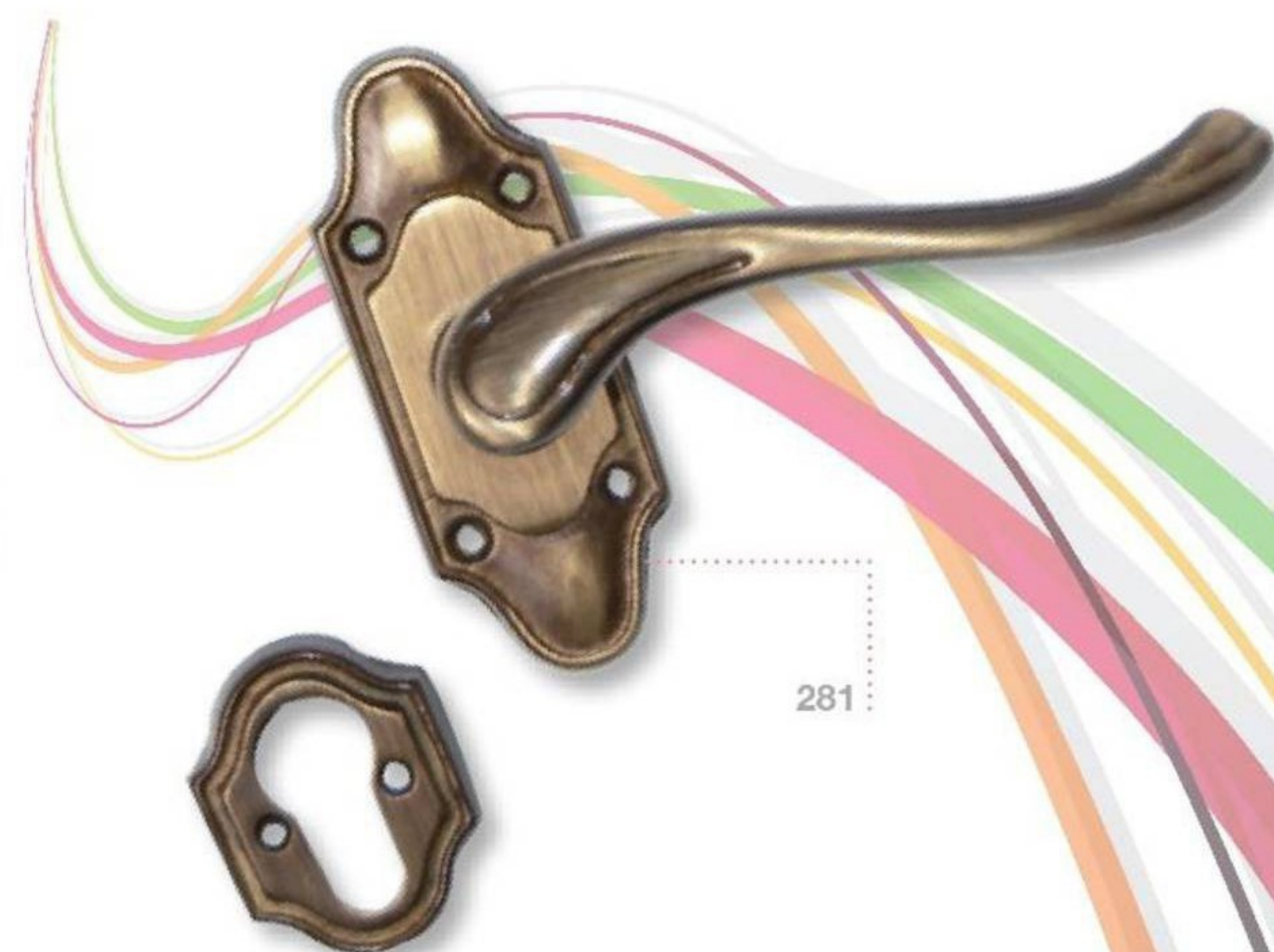

EPOCA

- 280 maniglia c/placca 280P
- 281 maniglia c/rosetta 0280 2M
- 283 maniglia c/rosetta 0340
- 284 martellina dry keep
- 285 cremonese
- 286 martellina

Esecuzione: OLV - OBG

CAPRICE



2110:

CAPRICE

2110 maniglia c/placca 430P
2114 martellina dry keep

g. 868

Esecuzione: OLV - OBS

PETRA



430:

PETRA

430 maniglia c/placca 430P

Esecuzione: OLV - OBS

ERICA



120:

125:

EXPORT



220:

225:

ATHENA



150:

155:

ERICA

120 maniglia c/placca 120P
121 maniglia c/rosetta 0220
124 martellina dry keep
125 cremonese
126 martellina
380 maniglia c/placca 120/M+220/P
Esecuzione: OBS

g. 665

g. 540

g. 315

g. 680

EXPORT

220 maniglia c/placca 220P
221 maniglia c/rosetta
225 cremonese
226 martellina
Esecuzione: OBS

g. 548

g. 410

g. 270

ATHENA

150 maniglia c/placca 120P
151 maniglia c/rosetta
155 cremonese
156 martellina
Esecuzione: OBS

g. 530

g. 410

g. 270

INCA



- INCA**
- | | | |
|-----|-------------------------|--------|
| 170 | maniglia c/placca 170P | g. 490 |
| 171 | maniglia c/rosetta 0170 | |
| 172 | maniglia c/rosetta PVC | |
| 175 | cremonese | |
| 176 | martellina | g. 225 |

Esecuzione: OLV - OBS

MAYA



- MAYA**
- | | | |
|-----|-------------------------|--------|
| 180 | maniglia c/placca 70P | g. 560 |
| 181 | maniglia c/rosetta 0170 | |
| 185 | cremonese | |
| 186 | martellina | g. 265 |

Esecuzione: OBS

SELENIA



- SELENIA**
- | | | |
|-----|-------------------------|--|
| 090 | maniglia c/placca 090P | |
| 091 | maniglia c/rosetta 0170 | |
| 095 | cremonese | |
| 096 | martellina | |

Esecuzione: OBS

DABY



- DABY**
- | | | |
|-----|-------------------|--------|
| 140 | maniglia c/placca | g. 540 |
|-----|-------------------|--------|

Esecuzione: OBS

BAROCCO



- BAROCCO**
- | | | |
|-----|--------------------------------|--------|
| 070 | maniglia c/placca mec 070P | g. 575 |
| 071 | maniglia c/rosetta | |
| 080 | maniglia c/placca pesante 070P | g. 680 |
| 081 | maniglia c/rosetta 070 | |
| 075 | cremonese | |
| 076 | martellina | g. 220 |

Esecuzione: OB

RINASCIMENTO



- RINASCIMENTO**
- | | | |
|------|-------------------------|--|
| 2940 | maniglia c/placca 2230P | |
| 2942 | maniglia c/placca PVC | |
| 2943 | maniglia c/rosetta 0340 | |
| 2944 | martellina dry keep | |

Esecuzione: OBA - OLV

AMBRA

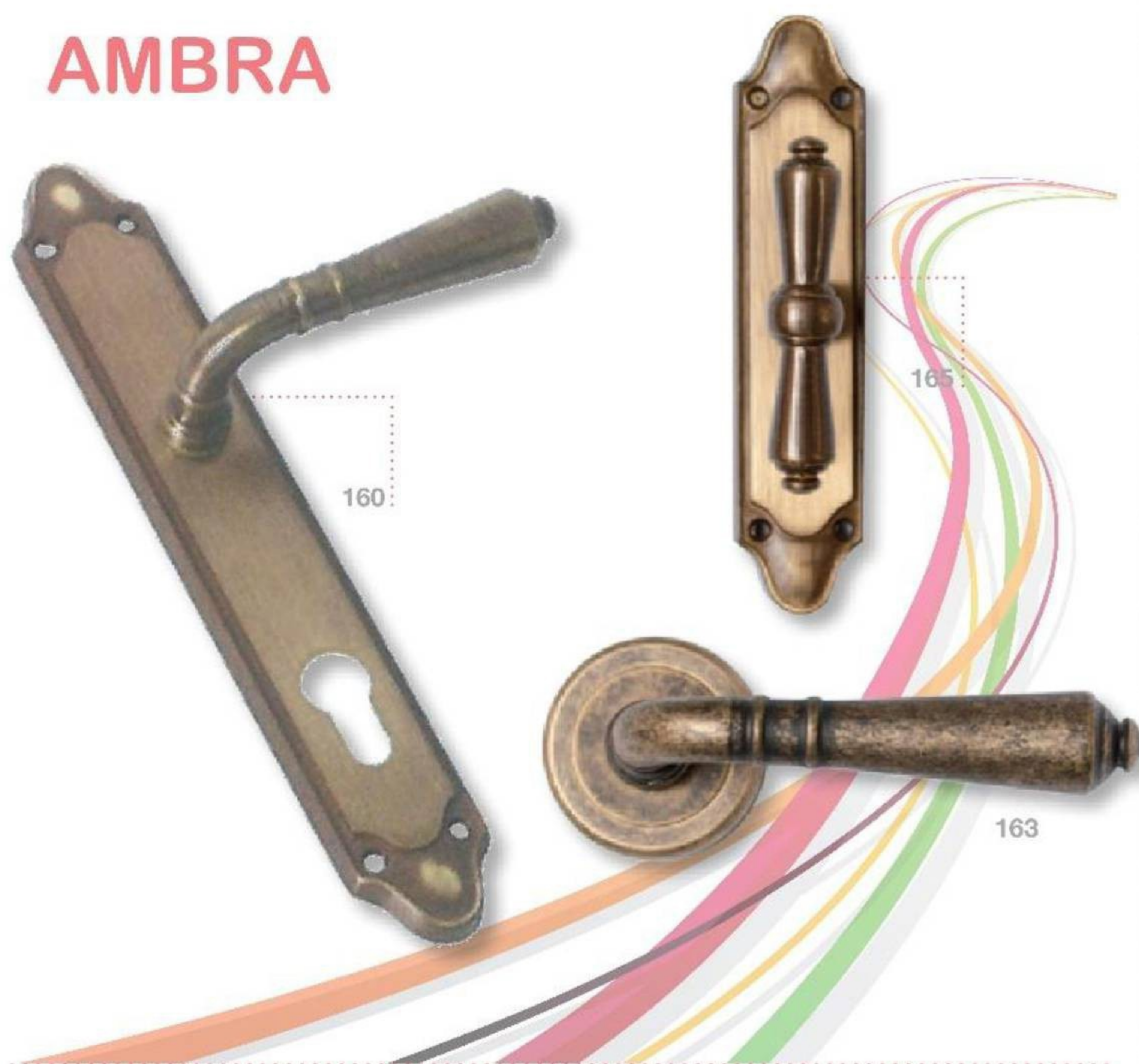

AMBRA

- 160 maniglia c/placca 280P
- 162 maniglia c/placca PVC
- 163 maniglia c/rosetta 0340
- 164 martellina dry keep
- 165 cremonese
- 166 martellina

Esecuzione: OBG - OBA

NEW AGE

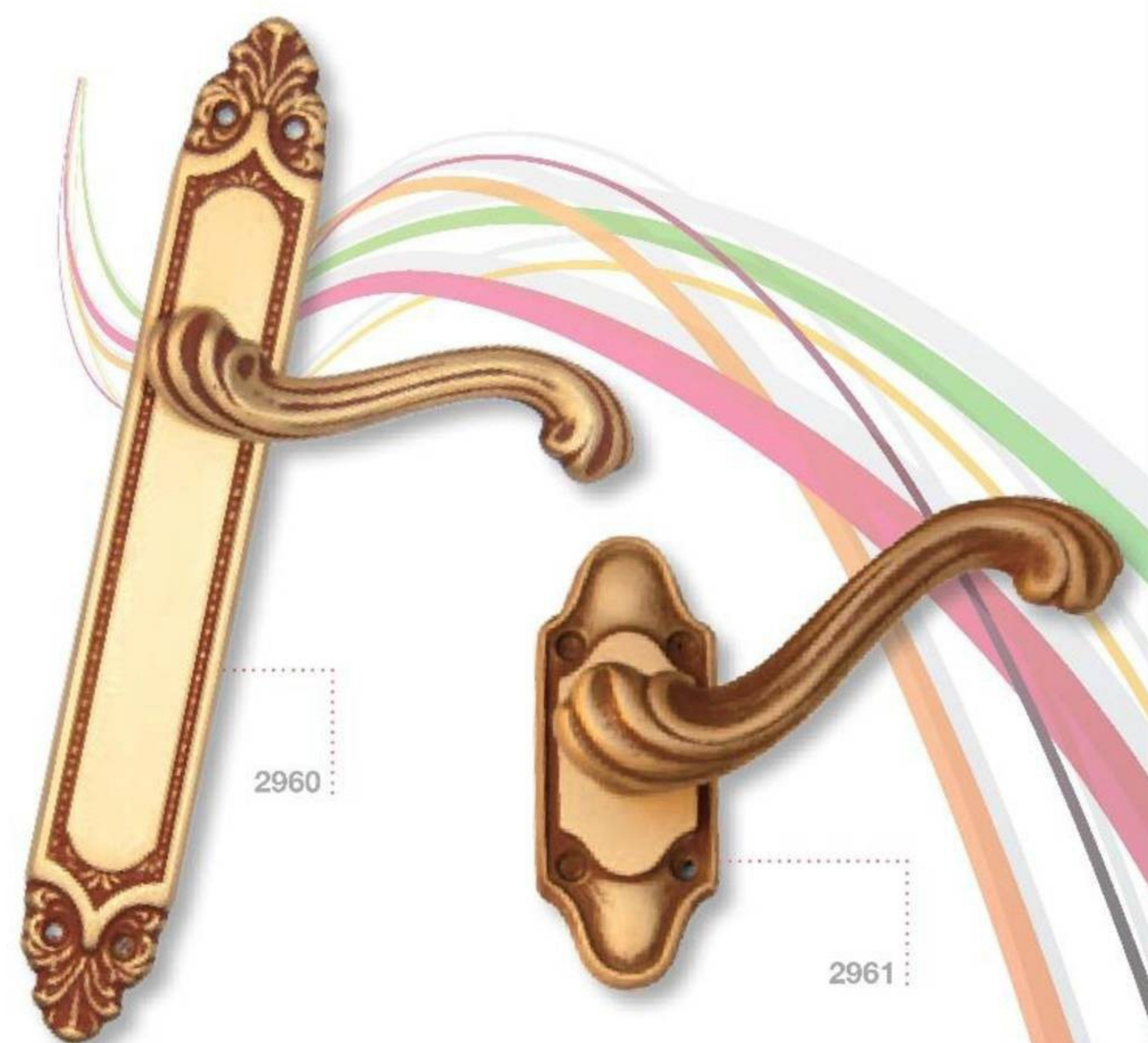

NEW AGE

- 2960 maniglia c/placca 430/P
- 2961 maniglia c/ rosetta 0281

Esecuzione: OBG - OBA - ROSSO ANTICO

ROMANTICA



ROMANTICA

- 2970 maniglia c/placca

Esecuzione: OBS

CLASSIC



CLASSIC

- 2980 maniglia c/placca
- 2983 maniglia c/rosetta 0340
- 2984 martellina dry keep

ARTICOLI IN ZAMA

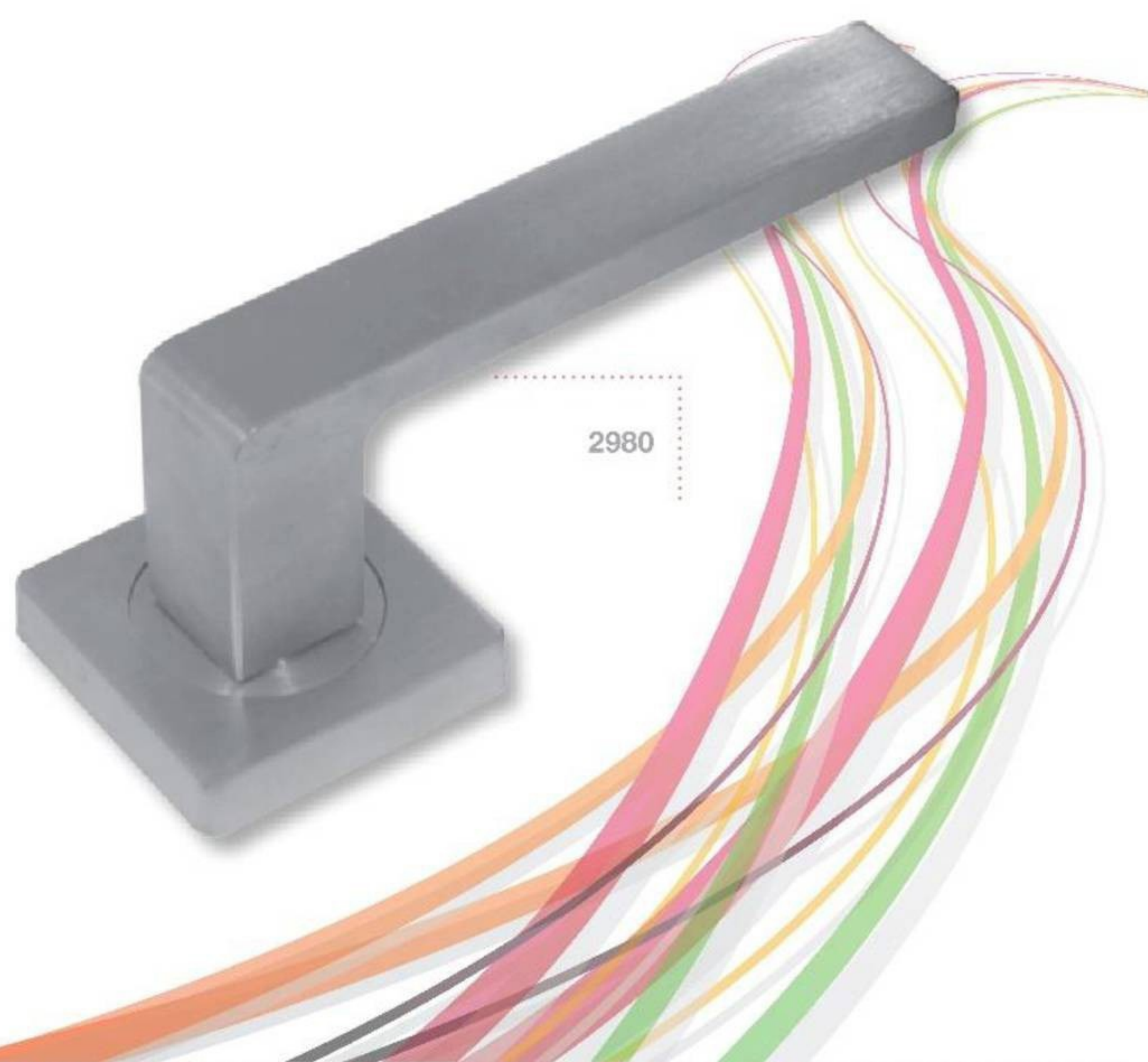

ARTICOLI IN ZAMA

- 2980 maniglia c/rosetta quadrata
- 2990 maniglia c/rosetta quadrata
- 3000 maniglia c/rosetta tonda



ARTICOLI IN POLYAMIDE



- 3010 maniglia c/placca
- 3012 maniglia c/rosetta tonda
- 3013 maniglia c/rosetta ovale
- 3014 martellina dry keep

- 3020 maniglia c/placca
- 3022 maniglia c/rosetta tonda
- 3023 maniglia c/rosetta ovale
- 3024 martellina dry keep



051 WC



052/B



053/B

SECRET

- 051 ovale cieco con sottoplastica
- 051/B ovale c/foro con sottoplastica
- 052 ovale cieco
- 052/B ovale c/foro spostato o centrale
- 053 quadrato cieco con sottoplastica
- 053/B quadrato c/foro con sottoplastica

Esecuzione: OLV - OBG - OBA - CH/SAT
CH - OBO - OBCO

045



046



SECRET

- 045 rotondo cieco
- 045/b rotondo c/foro
- 045/WA rotondo per bagno
- 045/WB rotondo per bagno
- 046/B ditale

Esecuzione: OLV - OBG - CH/SAT - CH

045W



045WA



045WB



047 WC



047



SECRET QUADRI

- 047 quadrato cieco
- 047/WC quadrato per bagno
- 048 ditale quadrato

Esecuzione: OLV - OBG - CH/SAT - CH

048



SAFETY ALT WIEN



K1 SAFETY



K1
Pomolo Orione fisso + maniglia interna a scelta
+ sottoplacca in acciaio

K5 SAFETY



K5
Pomolo Leopard fisso + defend + maniglia interna a scelta
+ sottoplacca in acciaio

K9 SAFETY



K9
Maniglia fissa esterna + maniglia interna a scelta
+ sottoplacca in acciaio

PLACCHE

Assembly combinations: any model of handel can be fixed on different plates.
Tutte le maniglie possono essere montate su ogn tipo di placca.

I:E: Art. 2100 (displaied in catalogue) - Possibile alterntive art. 2100/M/2230/P (handle model 2100 assembled on plate art. 2230)
Esempio: art. 2100 Asia - Possibile alternativa art: 2100M/2230P (maniglia 2100 montata su placca 2230)

Model	AxBxC	PESO
2140P	278x47x10	g. 204
2060P	254x42x10	g. 140
2065P	165x38x12	g. 100
2069P	150x40x14	g. 100
22P	278x47x10	g. 200
2230P	250x42x10	g. 150
2235P	164x38x8	g. 85
270P	255x43x10	g. 174
275P	174x39x10	g. 85
270.4P	255x43x10	g. 180
60P	255x43x11	g. 145
460P	248x44x 9	g. 170
450P	253x33x 8	g. 120
455P	170x37x10	g. 100
170P	255x36x 7	g. 106
175P	165x36x8,5	g. 90
2400P	165x39x 9	g. 90
200P	250x38x9	g. 140
205P	180x36x10	g. 100
209P	150x40x14	g. 100
209I/F		
2150P	240x37x10	g. 135
2155P	162x37x10	g. 86
2100P	250x40x11	g. 150
2105P	174x38x11	g. 100
280P	250x40x11	g. 148
285P	173x39x12	g. 106



	AxBxC	PESO
203P	230x28x 9	g. 140
370P	255x42x12,5	g. 186
375P	165x42x14	g. 115
2050P	252x42x10	g. 155
26P	220x40x 7	g. 140
26PC	220x40x 7	g. 140
300P	248x40x10	g. 146
305P	180x39x12	g. 100



	AxBxC	PESO
90P	222x35x7	g. 125
95P	166x37x9	g. 84
120P	245x37x7,5	g. 130
125P	180x37x10	g. 110
220P	238x38x 7	g. 138
225P	180x37x10	g. 110
430P	268x40x 8	g. 174
140P	245x39x7,5	g. 130



	AxBxC	PESO
70P	236x38x 8	g. 130
75P	170x38x10	g. 112
DHE	220x59x10	g. 185
DH	220x59x10	g. 190
8005	160x59x 8	g. 167
15P	258x48x 8	g. 190
10P	258x49x12	g. 245
16P	258x48x 8	g. 190
18P	258x49x12	g. 245

ROSETTE



0248

Esecuzione:
OLV - OLV/OS - CH-CH/SAT - CH-NI/SAT



D38

D38

Esecuzione:
OLV - CH - OLV/OS - CH-CH/SAT



0380

0340

Esecuzione:
OLV - OBG - CH - NI/SAT - CH/SAT



PVC45

PVC50

Esecuzione:
OLV - OBG - CH - CH/SAT



0170

Esecuzione:
OLV - OBS



0200

Esecuzione:
OLV - OBG - OLS



0280

0220

Esecuzione:
OBS - OBG

0219F 0459F 0450D



PVC YALE

Esecuzione:
OLV - OBG - CH - CH/SAT



0345

Esecuzione:
OLV - OBA - CH/SAT - NI/SAT - CH

CHEOPE



CHEOPE

6050 maniglione int 200 gr. 1310

Esecuzione: OLV - OBG - CH/SAT - OBGO - OBA

ASIA

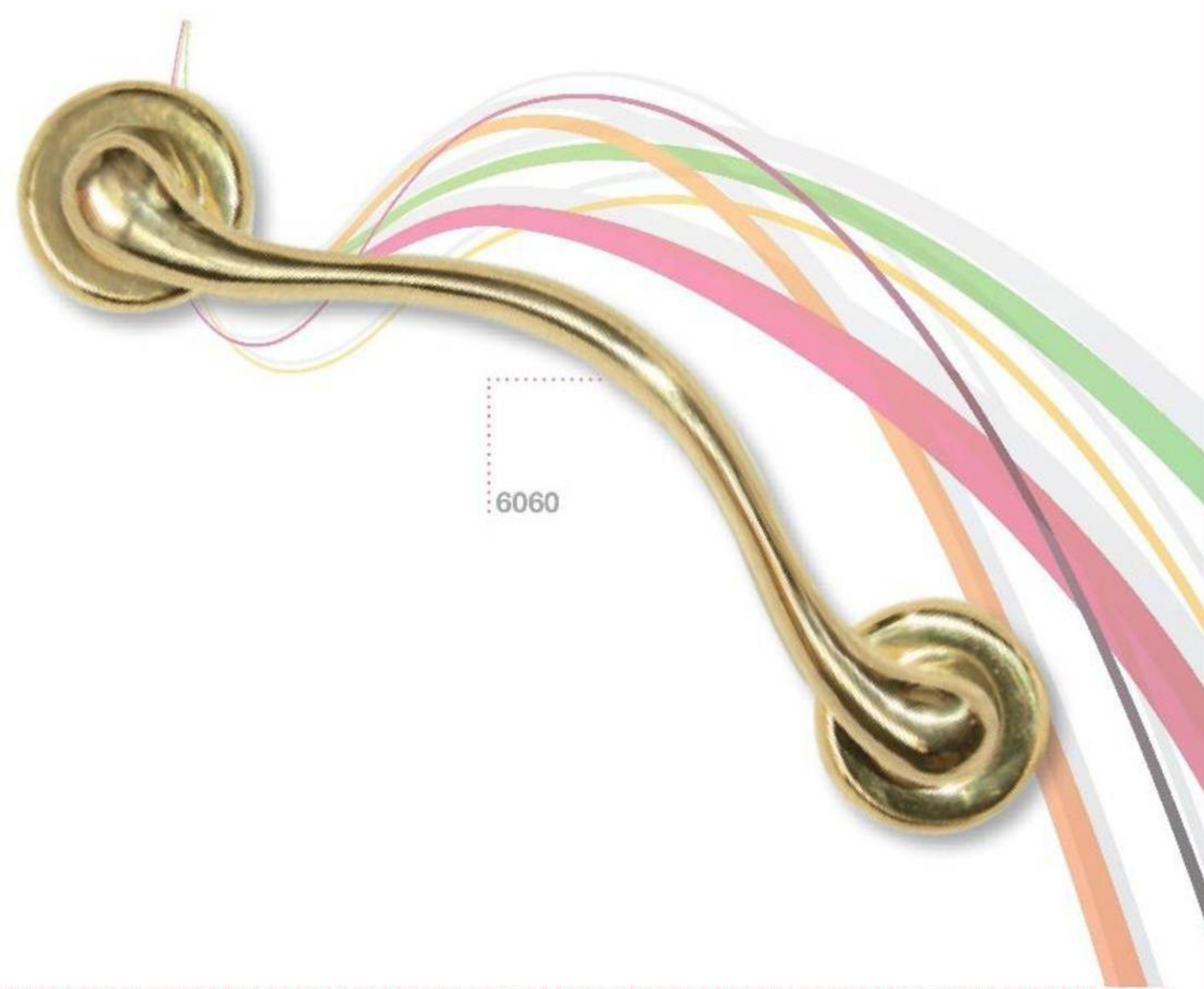

ASIA

6060 maniglione int 210 gr. 740

Esecuzione: OLV - OBG - CH/SAT - OBGO - OBA - OBO

MILLENIUM



MILLENIUM

690 maniglione int 250 gr. 1350
691 maniglione int 250 c/rosetta 0340 gr. 1520

Esecuzione: OLV - OBG - CH - CH/SAT

EXCALIBUR



EXCALIBUR

645 maniglione int 200 gr. 1000

Esecuzione: OLV/OS - OLV/OBG - CH-CH/SAT NI-NI/SAT

QUBIK



QUBIK

695 maniglione int 200
696/B maniglione int 200 c/rosetta 0345
6080 maniglione int 200

Esecuzione: CH - CH/SAT - CH-CH/SAT

FIJI



FIJI

685 maniglione su ros 0345 quadrata porcellana champagne int 200

Esecuzione: OLV - OBG - OBA

ROMANTICA



ROMANTICA

6070 maniglione int

Esecuzione: OBG - OBA

SAMOHA

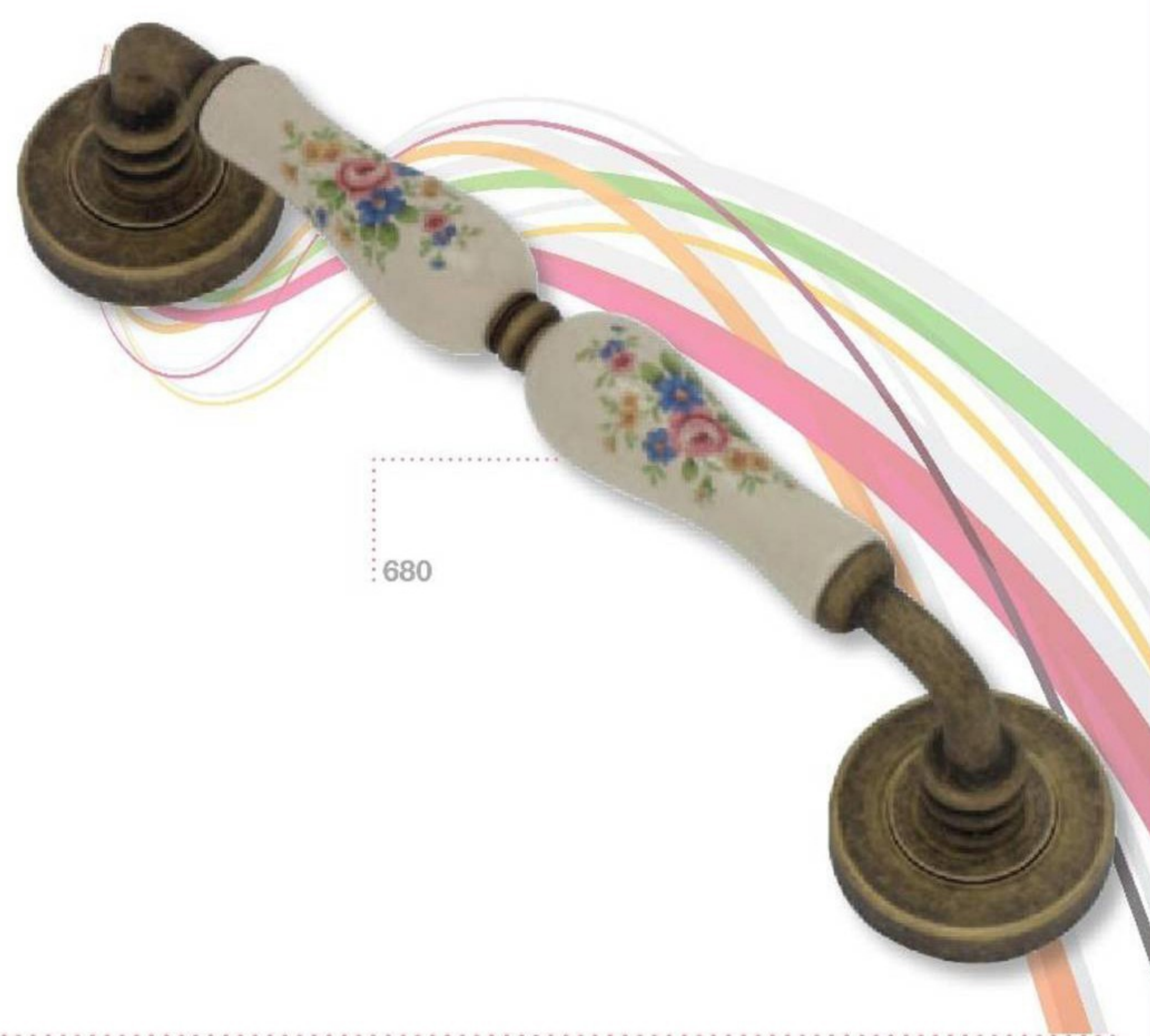

SAMOHA

680 maniglione int 220 gr. 470

Esecuzione: OLV - OBG - OBA - OBGO
Impugnatura: porcellana champagne - bianco
champagna decolo - A - B - C
champagne dipinto - D - E
craquelée - F

GIADA



GIADA

610 maniglione spostato c/rosetta 0200 240x67x78 i 175
612 maniglione spostato su rosette 0340 230x65x80 i 175

g. 740
g. 820

Esecuzione: OLV - OBG

LAGUNA

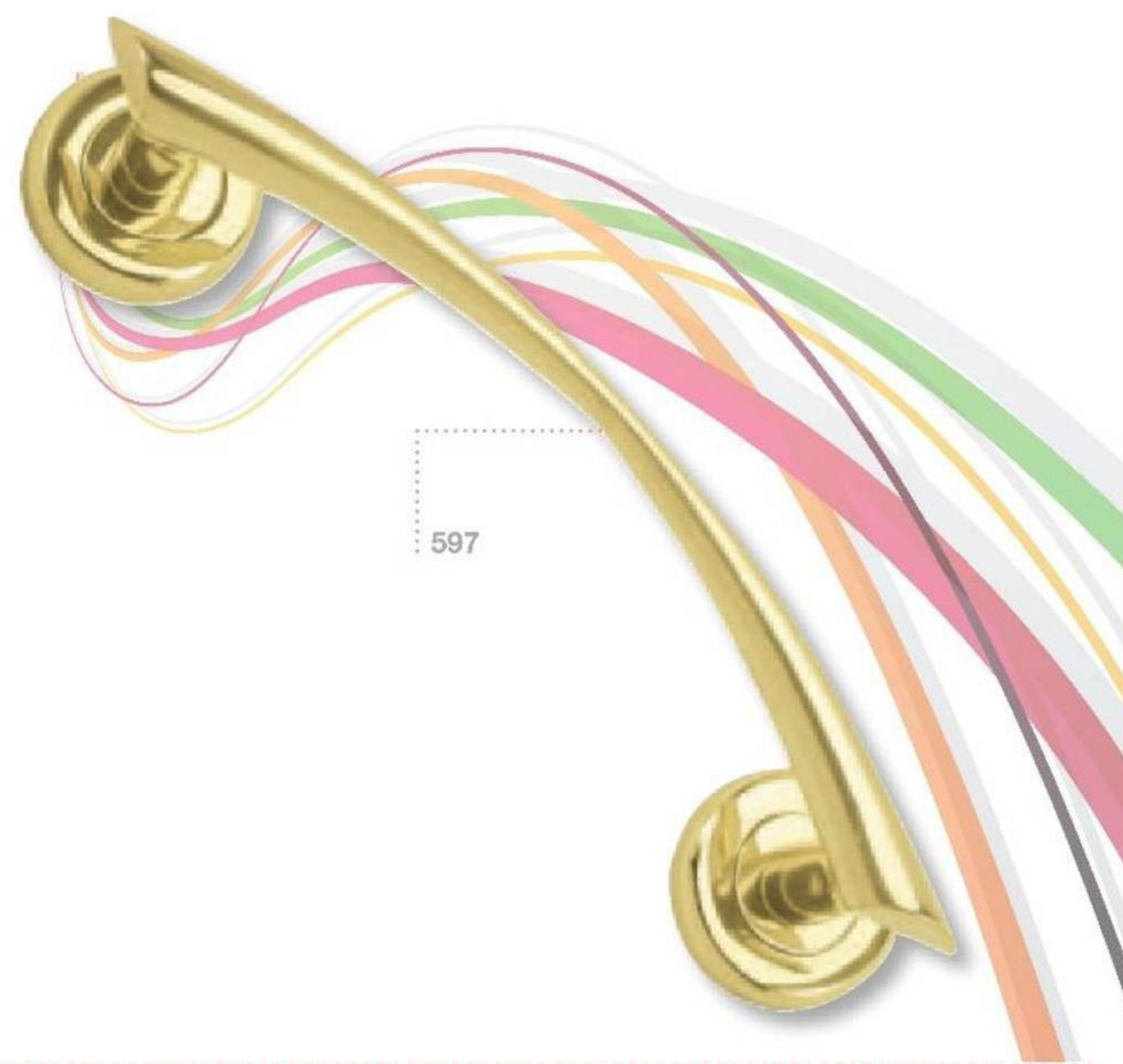

LAGUNA

597 maniglione spostato int 200 gr. 800
Esecuzione: OLV - OBG - CH - CH/SAT

CARINA



CARINA

670 maniglione spostato 240x78x53i 190 g. 770
Esecuzione: OLV - OBG - CH - CH/SAT - PVD



CARINA dritto

675 maniglione int 180
Esecuzione: OLV - OBG - CH - CH/SAT

KARISMA



595

KARISMA zancato
595 maniglione zancato int 190 gr. 760
Esecuzione: OLV - OBG

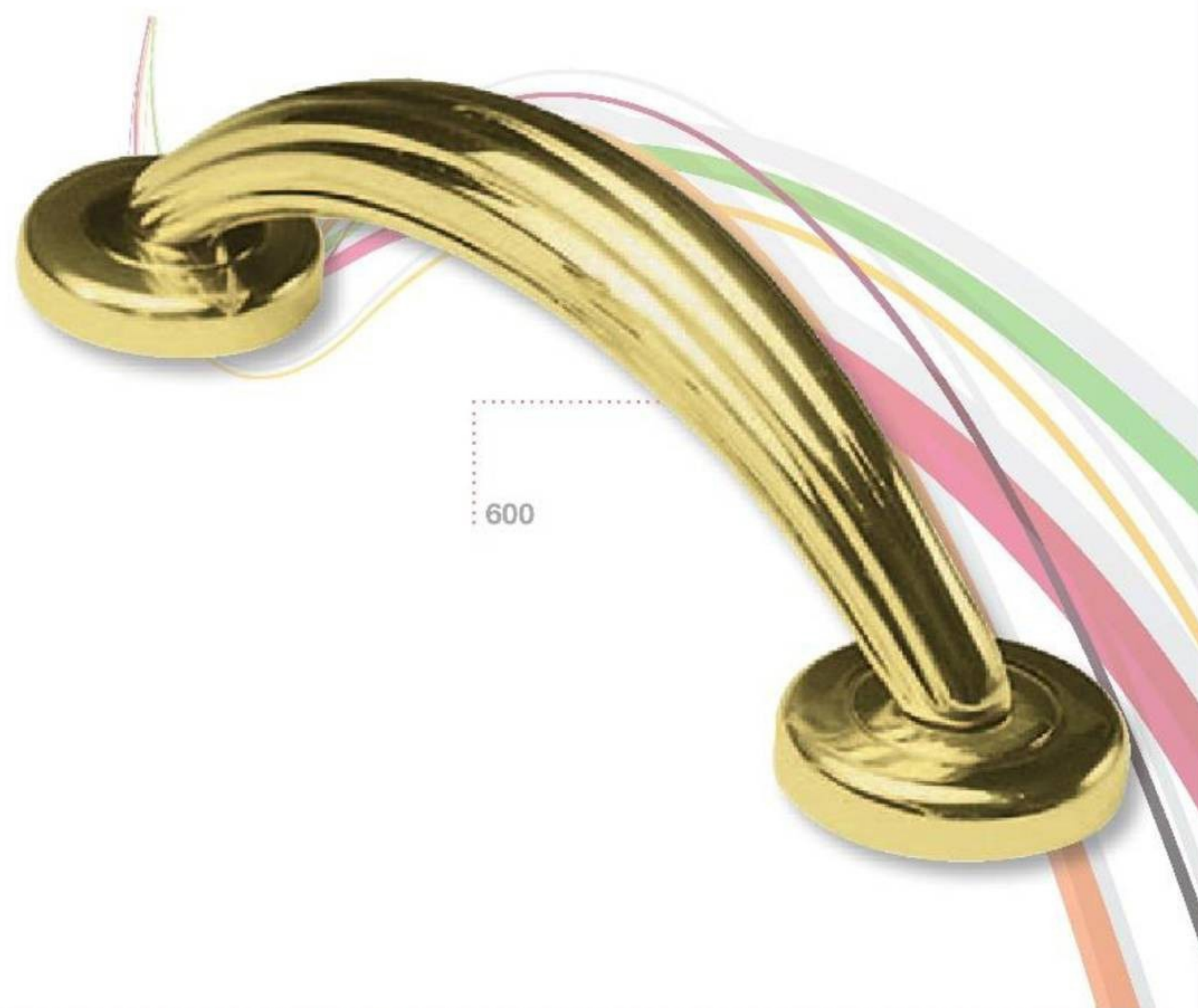

600

KARISMA
600 maniglione int 190
Esecuzione: OLV - OBG

BRAHMA



655

BRAHMA

655 maniglione BRAHMA diritto int 200 gr. 1240
Esecuzione: OLV - OBG



650

650 maniglione BRAHMA zancato int 200 gr. 1260
Esecuzione: OLV - OBG

TUAREG



TUAREG

6040 maniglione rosetta 02060 int 230 gr. 550
6040/B maniglione rosetta 0340

Esecuzione: OLV - OBG - OBA - OBO - OBGO

IMPERO



IMPERO

616 maniglione 280x54x63 i 200 g. 810

Esecuzione: OLV - OBG

LUIGI XIV

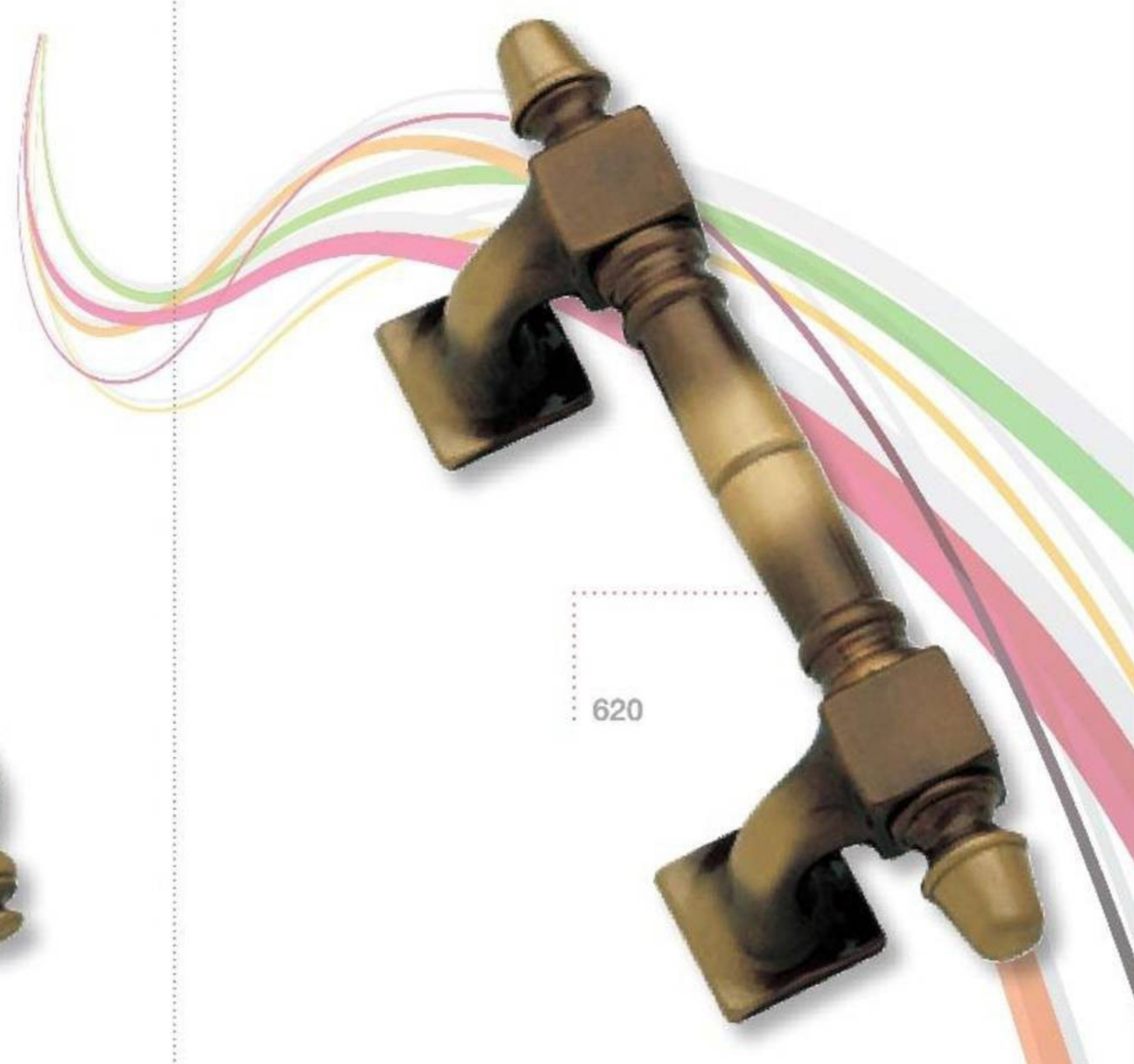

LUIGI XIV

620 maniglione 250x60x73 i 150 g.1000

Esecuzione: OLV - OBG

AMBRA



AMBRA

603 maniglione ros. 2060 260x55x50 g. 500
603/PVC maniglione ros. PVC
603/0340 maniglione ros 0340

Esecuzione: OLV - OBS

AMBRA spostato



AMBRA

604 maniglione 245x48x68 g. 500

Esecuzione: OLV - OBS

SFERA



SFERA

628 maniglione
232x70x35 i 200 g. 740

Esecuzione: OLV - OBG

DIRITTO



DIRITTO

630 maniglione
i 200 g. 735

Esecuzione: OLV

MEZZALUNA



MEZZALUNA

625 maniglione
220xø20x80 i 170 g. 840

Esecuzione: OLV - CH/SAT

GLORIA



GLORIA
648 maniglione int 160
649 maniglione int 200 gr. 840

Esecuzione: OLV/OBG - OLV/OS - CH-CH/SAT - CH-NI/SAT - OLV

ELISIR



ELISIR
6005 maniglione
6025 maniglione con puntini

Esecuzione: OLV/OS - OLV/OBG - CH-CH/SAT

GELOSIA



GELOSIA
635 maniglione int 150 rosetta 02060

Esecuzione: OLV/OBG - OLV/OS - OBA - CH-CH/SAT - CH/SAT

RUGIADA



RUGIADA
647 maniglione int 200 gr. 830

Esecuzione: OLV - OLV/OS - CH-CH/SAT

SAMOHA



SAMOHA
2469 pomolo accoppiato c/ros 0340

Esecuzione: OLV - OBG - OBA
Impugnatura: porcellana champagne - bianco
champagna - A - B
craquelèe - F

MARGHERITA



MARGHERITA
880 pomolo ø 70
885 pomolo ø 80

Esecuzione: OLV - OBG

SFERA



SFERA
745 pomolo ø 60
740 pomolo ø 70
746 pomolo accoppiato ø 60

Esecuzione: OLV - OBG

LEOPARD



LEOPARD
2700 pomolo su rosetta PVC 45

Esecuzione: OLV - OBG - CH - CH/SAT - NI/SAT

SCUDO



SCUDO
5010 pomolo su rosetta
5016 pomolo su rosetta accoppiato

Esecuzione: OLV - CHSAT

NEVADA



810

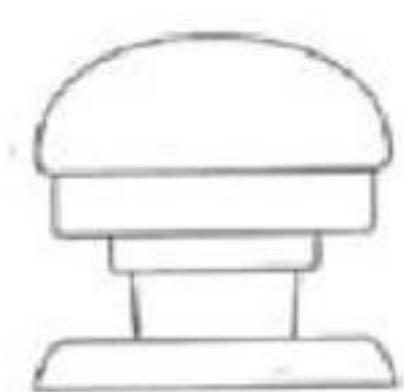

NEVADA

810 pomolo ø 70
815 pomolo ø 60
818 pomolo ø 90

Esecuzione: OLV - OBG - CH-SAT

PRESTIGE



800

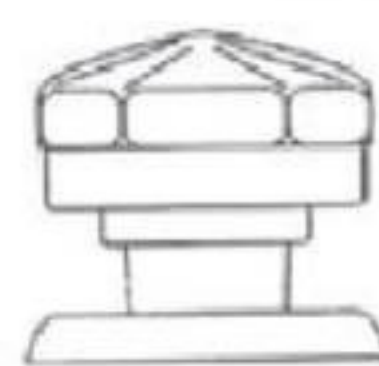

PRESTIGE

800 pomolo ø 70
805 pomolo ø 60
808 pomolo ø 90

Esecuzione: OLV - OBG - CH-SAT

DELTA



820

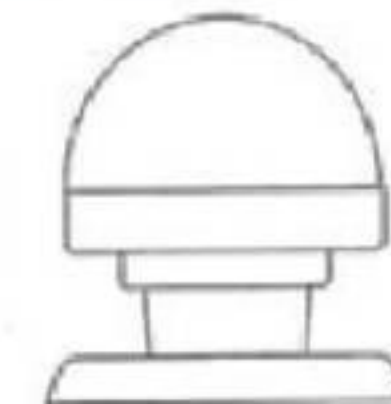

DELTA

820 pomolo ø 70
825 pomolo ø 60
828 pomolo ø 90

Esecuzione: OLV - OBG - CH-SAT

THEMA



840

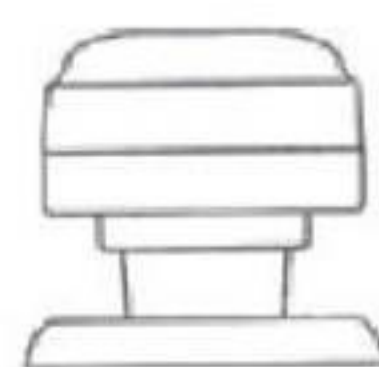

THEMA

840 pomolo ø 70
845 pomolo ø 60

Esecuzione: OLV - OBG - OLS

ARMONY



830



ARMONY

830 pomolo ø 70

Esecuzione: OLV - OBG

QUBIK



5020

QUBIK

5020 pomolo lato
Esecuzione: OLV - CHSAT

GIADA



720



GIADA

720 pomolo ø 70
725 pomolo ø 60
726 pomolo accoppiato ø 60
728 pomolo ø 80

Esecuzione: OLV - OBS - OLS - CH-CH/SAT - NI/SAT

AMBRA



730



AMBRA

730 pomolo ø 70
735 pomolo ø 60
736 pomolo ø 60 accoppiato
738 pomolo ø 80

Esecuzione: OLV - OBG - CH-CH/SAT

LINEA



700



LINEA

700 pomolo ø 70
705 pomolo ø 60
708 pomolo ø 80

Esecuzione: OLS - OBS

ERICA



710



ERICA

710 pomolo ø 70
715 pomolo ø 60
718 pomolo ø 80

Esecuzione: OLV - OBS

ORIONE



755



ORIONE

755 pomolo ø 50 su ros 45

Esecuzione: OLV - OBG - CH - CH/SAT - NI/SAT

WIEN



790



WIEN

790 pomolo ø 50

Esecuzione: OBS - OLV - CH - ANTH/G

MAYA EXPORT INCA



780 760 770

CENTROPORTA



720K 890 800K

EXPORT - INCA - MAYA

760 pomolo ø 70 Export
770 pomolo ø 70 Inca
780 pomolo ø 70 Maya

Esecuzione: OBS

CENTROPORTA

720K pomolo ø 70 Giada
800K pomolo ø 70 Prestige
890 pomolo ø 70 Uniblok

Esecuzione: OLV - OBG - OLS - CHSAT

TIRADOR

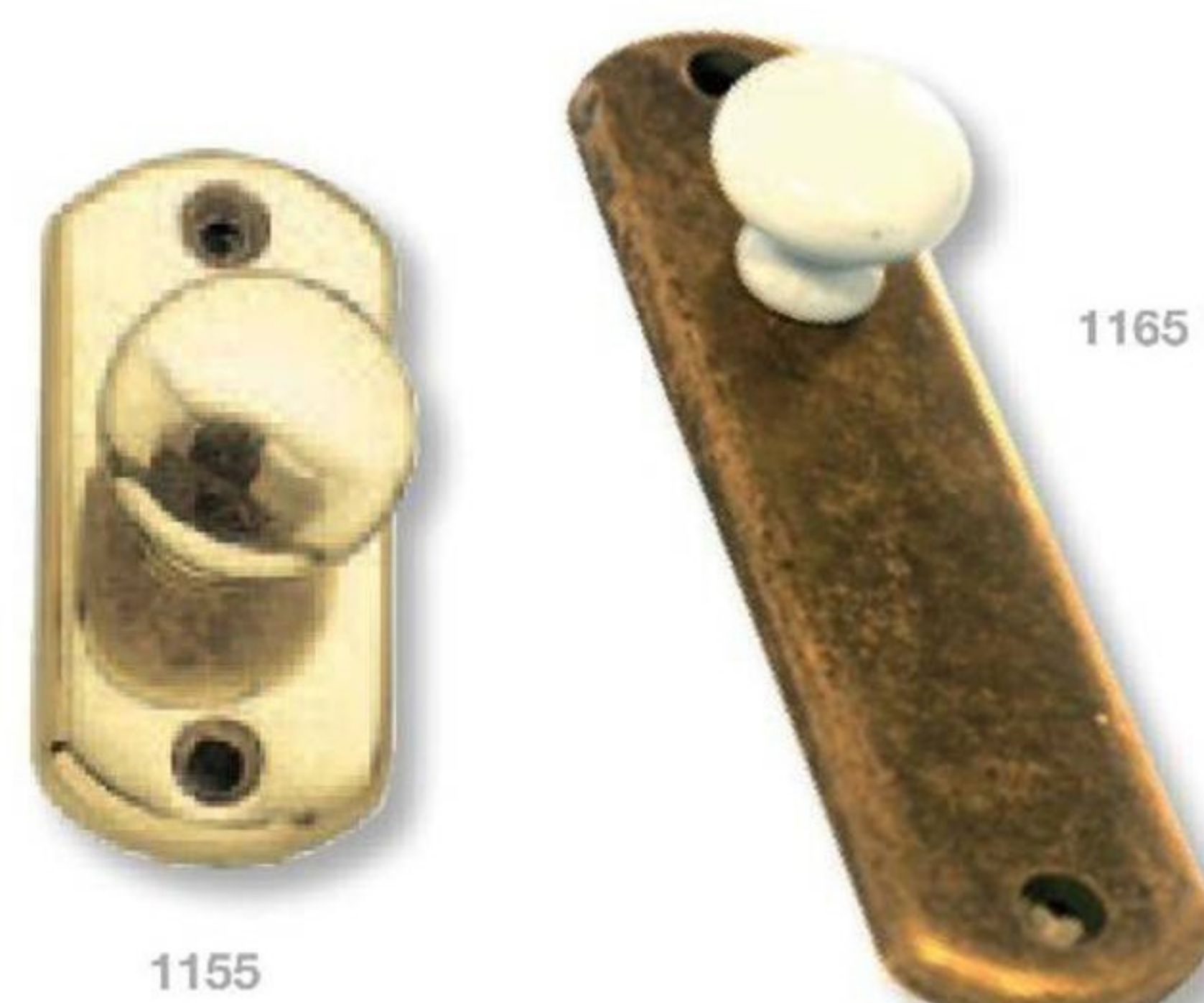

1155 1165

PORTABITI



920 930 900

TIRADOR

1155 tirador ROSETTA liscio
1165 tirador SU PLACCA liscio
1140 tirador ROSETTA sagomata
1145 tirador SU PLACCA sagomata

*Esecuzione: OLV - OBA - OBG
CHAMPAGNE - CRAQUELÉE*

GIADA

920 portabiti ø 70
Esecuzione: OLV - OBS - OLS - OBG

AMBRA

930 portabiti ø 70
Esecuzione: OLV - OBS - OLS - OBG

LINEA

900 portabiti ø 70
Esecuzione: OBS - OLS

ERICA

910 portabiti ø 70
Esecuzione: OBS - OLS

BATTENTI



BATTENTI

855	esagono ø100	g. 1070
857	esagono ø120	g. 1150
860	barocco	g. 1000
865	leone	g. 800
850	anello ø110	g. 700
852	anello ø130	g. 730

Esecuzione: OLV - OBG

COPRIAVVOLGITORI



560 GIADA
570 THEMA
Esecuzione: OLS - OBS

575 AURORA
580 DELTA
Esecuzione: OLV - OLS - OBG - CHSAT - CH

550 LINEA
555 ERICA
Esecuzione: OBS - OLS

COPRINTERRUTORI

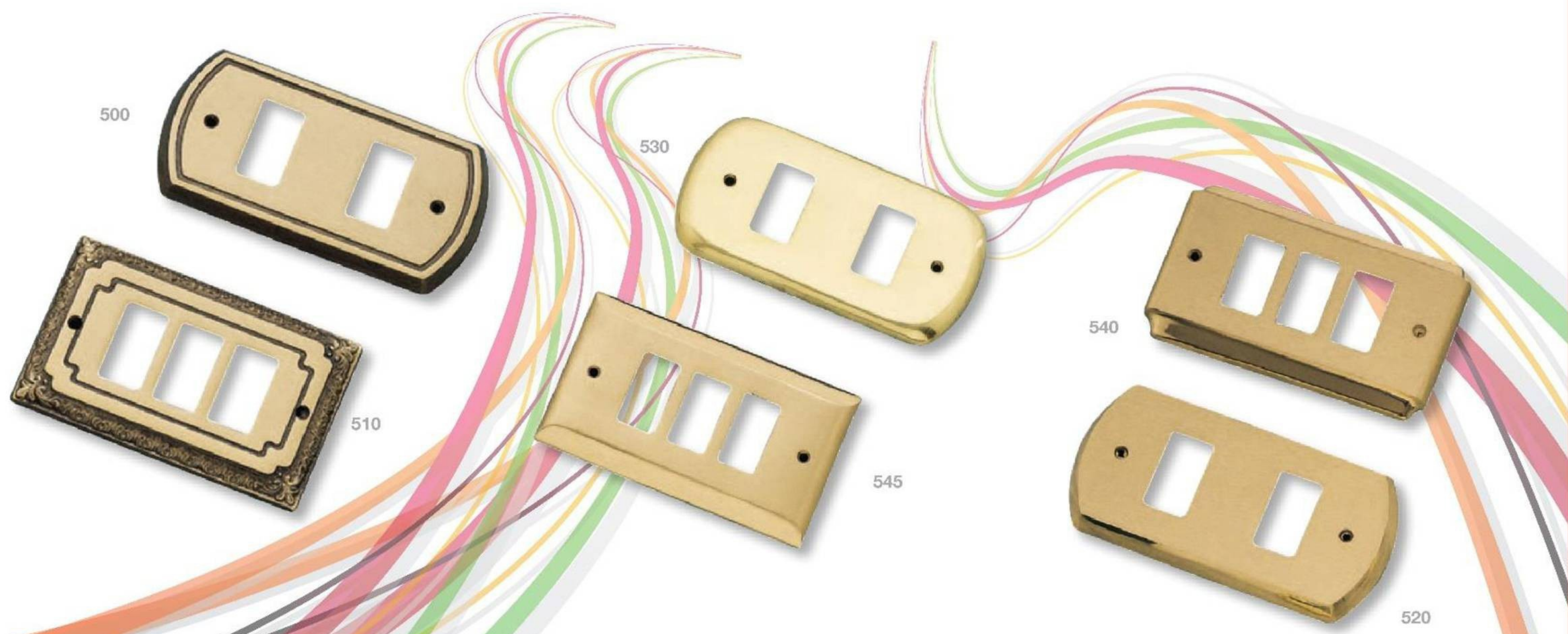

500 LINEA 1 - 2 - 3
510 ERICA 1 - 2 - 3
Esecuzione: OBS

530 DELTA 1 - 2 - 3
545 AURORA 1 - 2 - 3
Esecuzione: OLV - OBG - OLS - CH/SAT

520 GIADA 1 - 2 - 3
540 THEMA 1 - 2 - 3
Esecuzione: OLS - OBS

FERMAPORTE



FERMAPORTE

07 **Esecuzione: OLV - OBG - CH - CH/SAT - NI/SAT**
08 **Esecuzione: OLV - OBG - CH - CH/SAT - NI/SAT**
09 **Esecuzione: OLV - CH - CH/SAT**
11 **Esecuzione: OLV - CH - CH/SAT**

CHIAVI

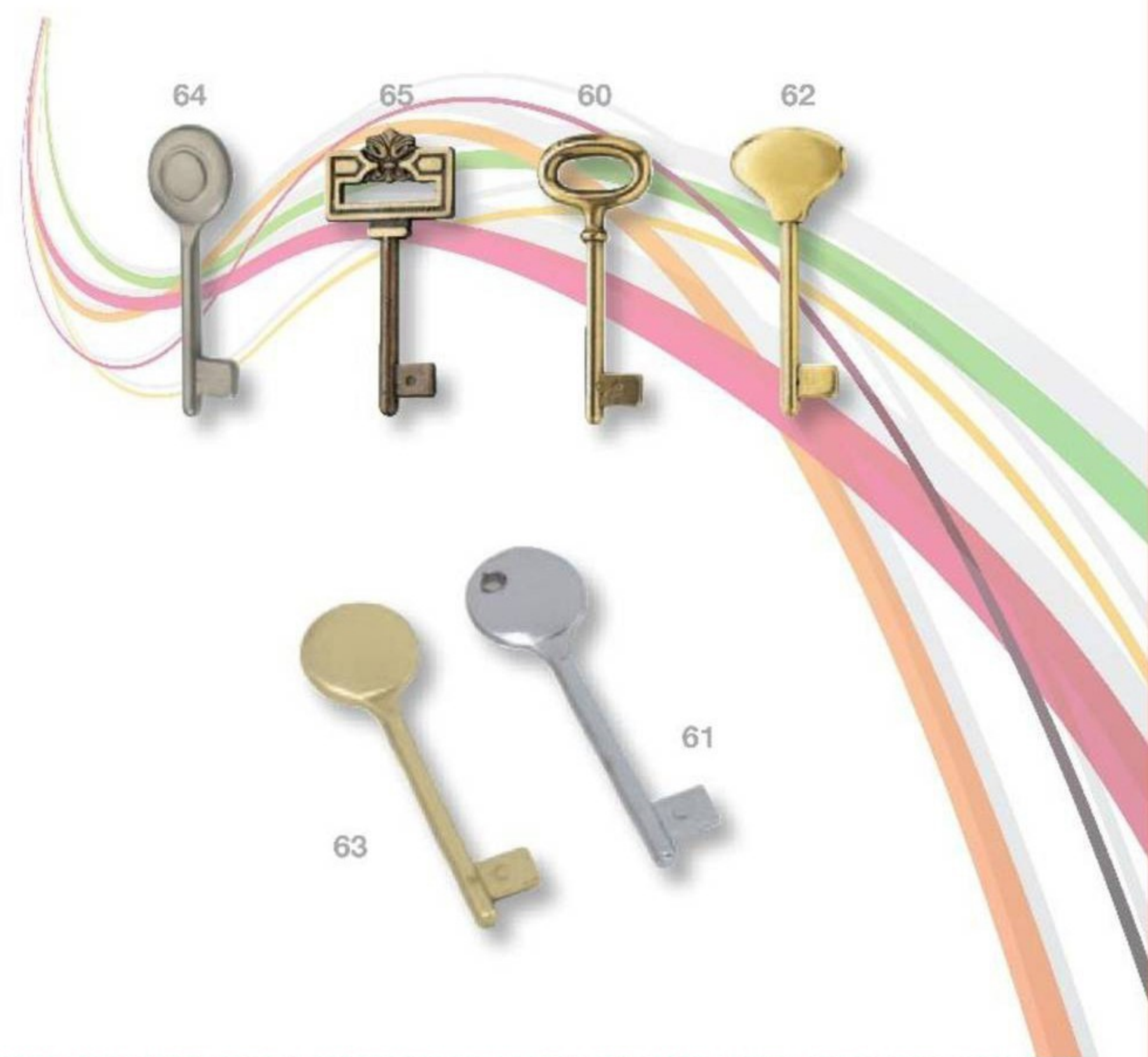

CHIAVI

60 DELTA **Esecuzione: OLV - OBG - CH/SAT - CH**
62 DIVA **Esecuzione: OBG - OLS - CH/SAT - CH**
64 DERBY **Esecuzione: OLV - OBG - OLS - CH/SAT - CH**
65 ERICA **Esecuzione: OBS**
63 MALIZIA **Esecuzione: OLV - OBG - OLS - CH/SAT - CH**
61 **Esecuzione: OLV - OBG - CH/SAT - CH**

CATENACCIOLI

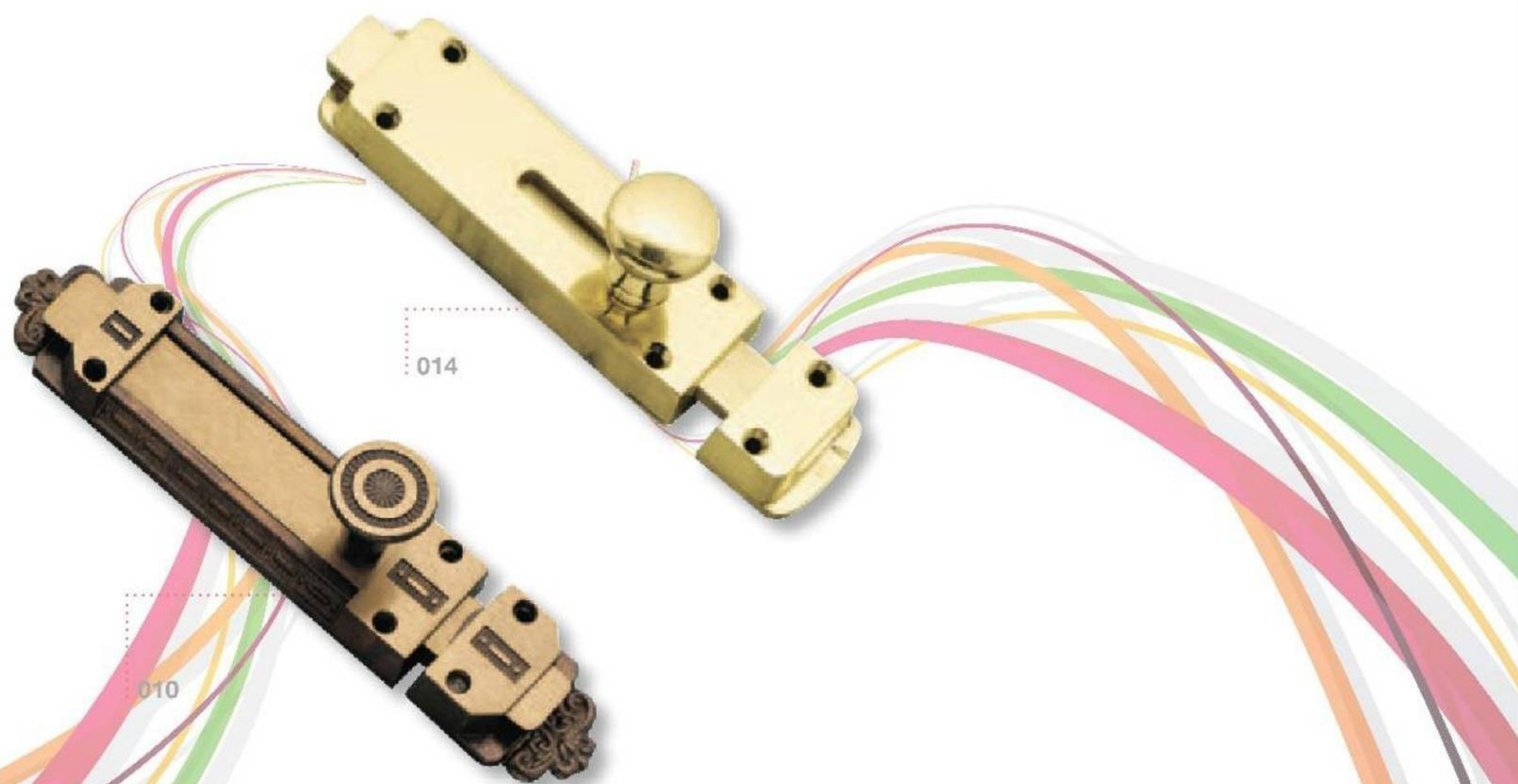

CATENACCIOLI

- 010 DABY 150mm - 200mm
 014 GIADA 150mm
 016 GIADA 200mm
 Esecuzione: OLV - OBS - OBG

FERMAPERSIANE



FERMAPERSIANE

- | | A | B | C | D | E | G |
|----|----|----|-----|-----|-----|-----|
| 34 | 60 | 80 | 100 | 120 | 140 | 200 |
- Esecuzione: OLV

NUMERI



NUMERI

- 12 100 mm c/chiodo e tass.
 13 75 mm
 Esecuzione: OLV

SCORRICINGHIA

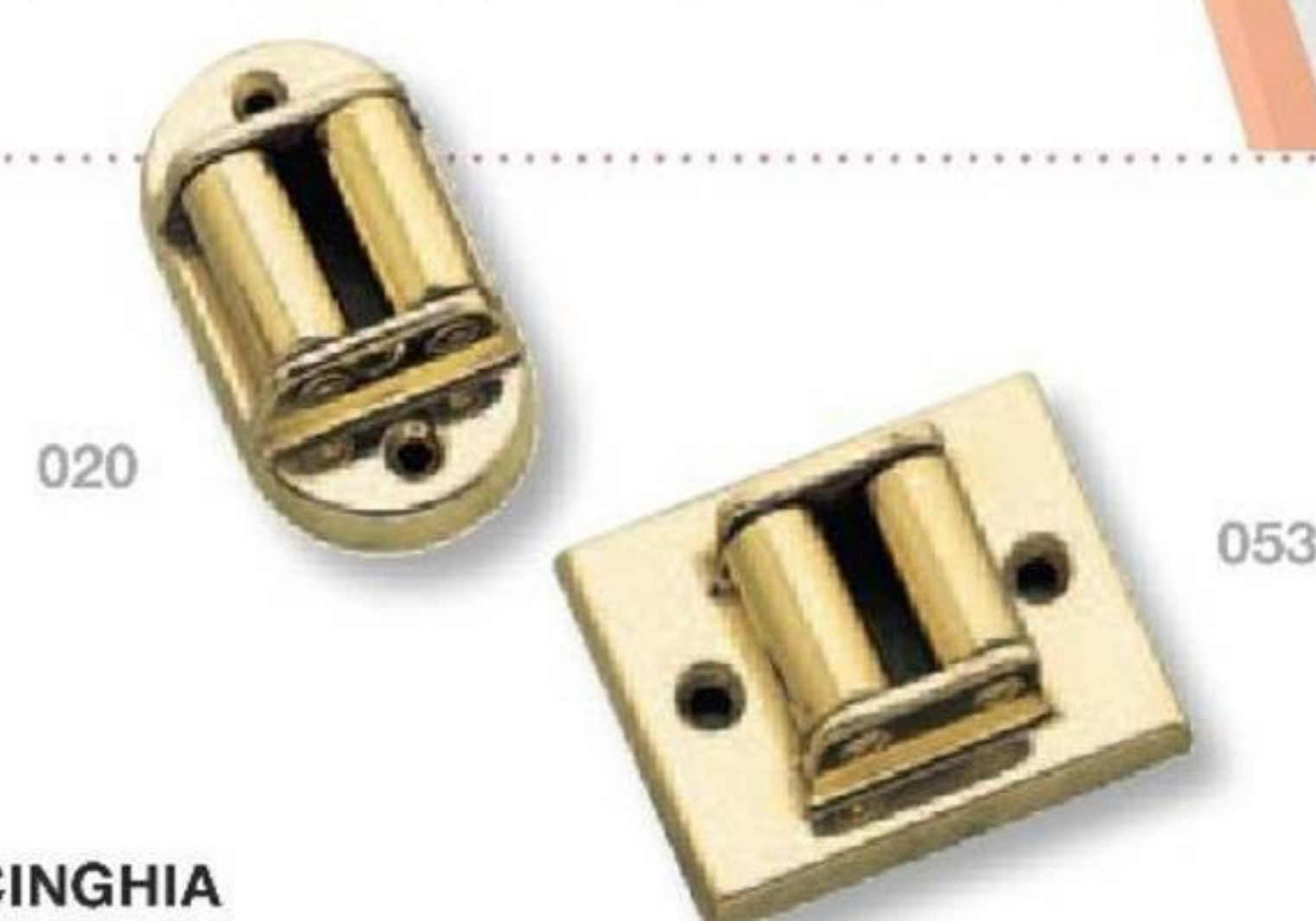

SCORRICINGHIA

- 020 ovale
 053 quadrato
 Esecuzione: OLV

SUPPORTI CORRIMANO



CORRIMANO

- 1200 supporto tondo su rosetta testa piana
 1200/b supporto tondo su rosetta testa concava
 26 supporto piano

Esecuzione: OLV - OBG - CH - CH/SAT

- 1262 finale tubo ø 30
 1264 finale tubo ø 35

Esecuzione: OLV - OBG - CH/SAT



- 1232 supporto diritto ø 30
- 1234 supporto diritto ø 35
- 1242 supporto diritto ø 30
- 1244 supporto diritto ø 35

Esecuzione: OLV - OBG - CH/SAT

- 1212 supporto spostato ø 30
- 1214 supporto spostato ø 35

- 1222 supporto spostato ø 30
- 1224 supporto spostato ø 35

BUCALETTERE



NOTTOLINI



ACCESSORI



COPERTURA e PORTANOME



NOTTOLINI

- 1300 standard mont. WC
 - 1380 WC su rosetta 0340
 - 1385 wc rosetta 0340 bianco/rosso
 - 031 limit. rosetta 0340
 - 030 limit. rosetta 200
- Esecuzione: OLV - OBG - CH - CH/SAT - NI/SAT**

ACCESSORI

- AP apricilindro
 - 059 copridado
 - 049 borchia fissaggio
- Esecuzione: OLV - OBG - CH - CH/SAT**

BUCALETTERE

- 023 252x77
- 024 252x76

Esecuzione: OLV - CH - CHSAT

- 2230N 250x42x10
- 22N 278x47x10
- 2140N 278x47x10

MOVIMENTI



MOVIMENTI

- 05P vite per pomoli
- 05E ferro espansione
- 055 DK acciaio
- 056 graz. fori
- 056/b graz. fori + ∇ 7
- 057 graz. c/bussola
- 057/b graz. c/bussola + ∇ 7
- 058 graz. perni
- 058/b M.P.
- 05N ferro con nipples ∇ 8 vite M10
- 01R riduzioni

M6-8-10

O5E

Vite c/bussola
M4

M5

M6 x
maniglioni accoppiati



O5P



























O5N

O1R

Viti Giunzione
M10

Ferro 2 tagli
□ 8 - 85 - A - 120

FINITURE

	lucido polished poli poliert		dorato gold plated 24 kr plaqué or 24 kr vergoldet 24 kr		rosso antico old red ancien rouge antiken rot
	cromato satinato matt chrome chromè satinè verchrom satiniert		antracite oro anthracite gold anthracite or anthrazit gold		argento antico old silver ancien argent antiken silver
	bronzato graffiato bronzed scratched bronzè griffè brüniert gekratz		cromato -cromato satinato chrome - mattchrome chromè - chromè satinè verchtome - verchtomesatiniert		ottone bronzato antico old bronze ancien bronze antiken bronze
	lucido satinato polished satined poli satinè poliert satinert		ottone nero laccato opaco lacquered dull black laqué noir mat matt schwarz lackiert		ottone oro opaco matt gold or mat matt gold
	bronzato sfumato bronzed fumè bronzè fumè brüniert fumè		antracite anthracite anthracite anthrexit		ottone bronzato graffiato opaco matt bronze scratched bronzè mat griffè brüniert matt gekratz
	titanio titanium titanium titanium		satinato satined satinè satiniert		ottone bronzato opaco matt bronze bronzè mat brüniert matt
	cromato chrome plated chromè verchrom		laccato bianco white lacquered laqué blanc lackiert weiss		ottone ramato antico old copper ancien cuivre alt kupfer
	nichelato satinato matt nichel nichel satinè matt vern		bronzato bronzed bronzè brüniert		ottone ramato graffiato scratched copper cuivre griffè kupfer gekratz

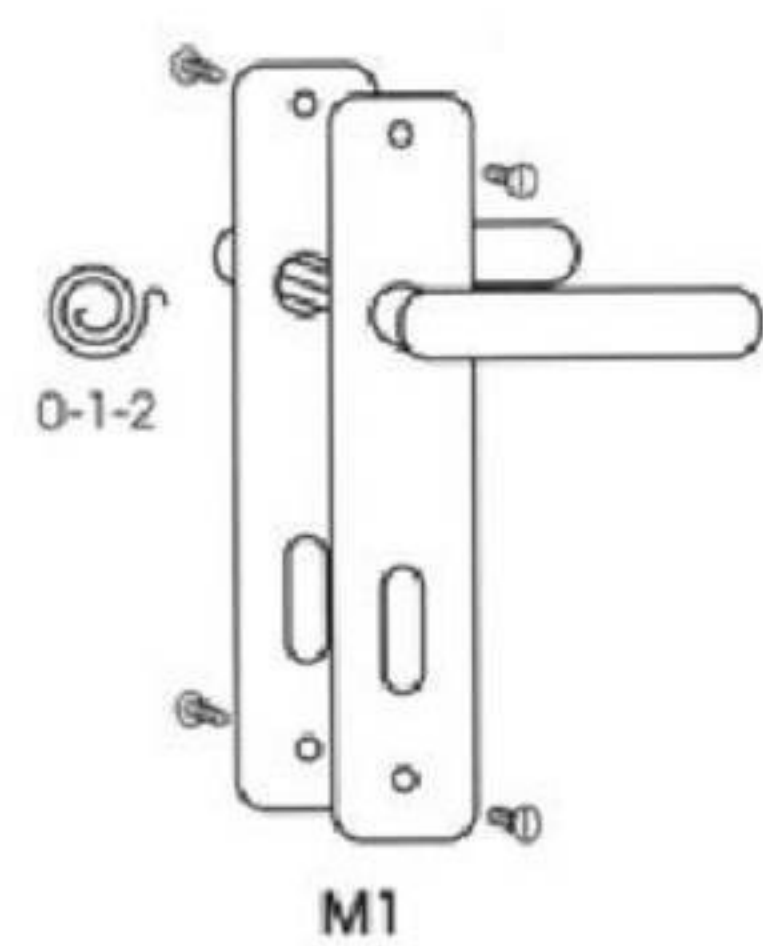

M1

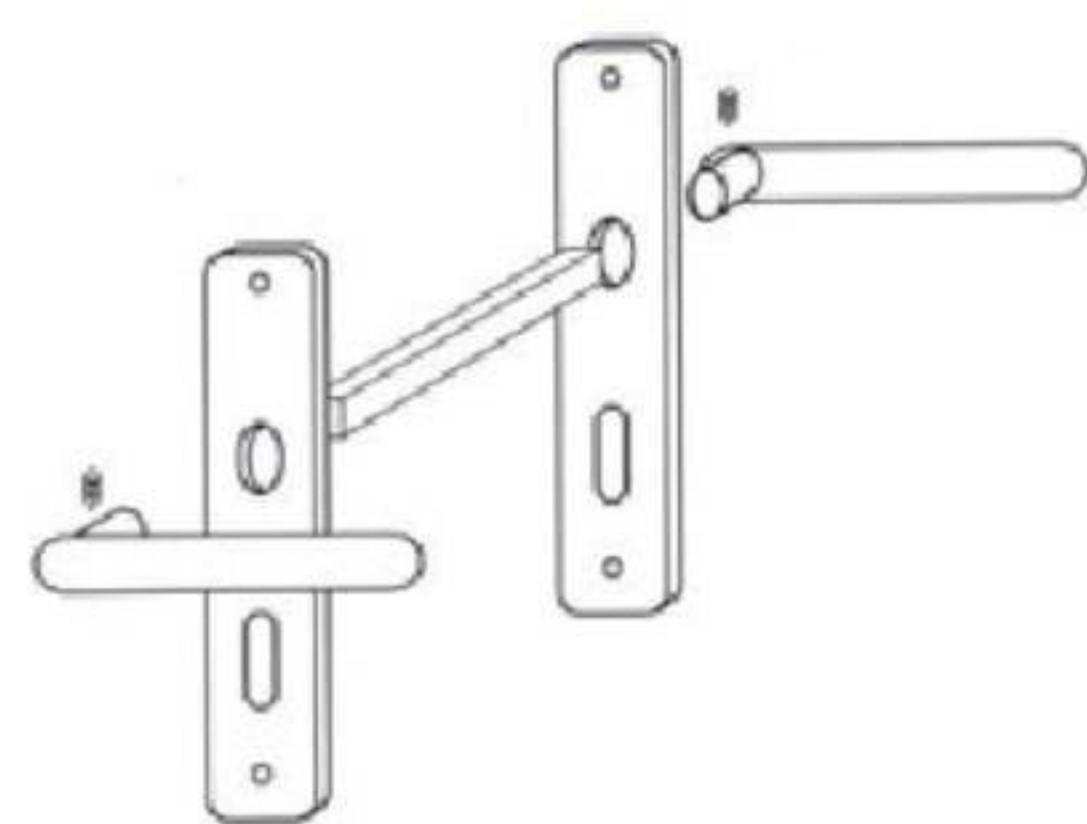

M5

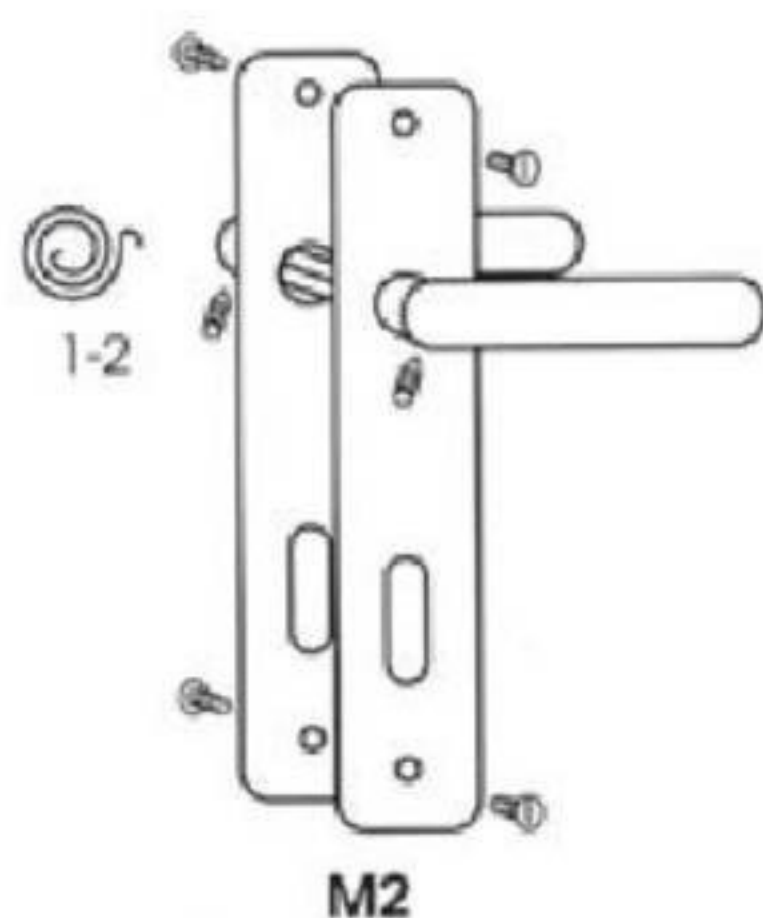

M2

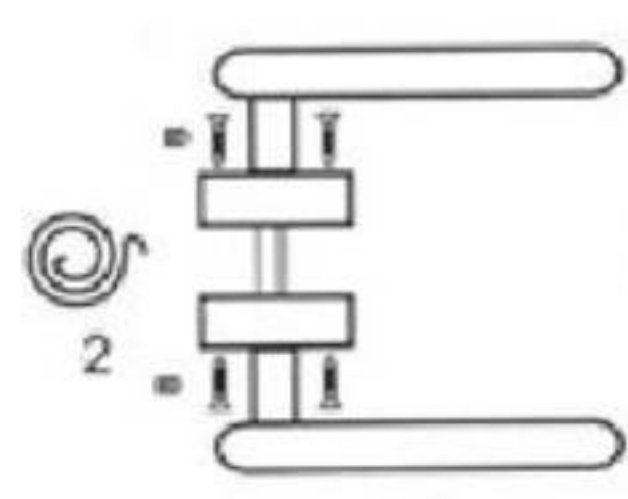

M6

Rosetta coprivite Ø 340-Ø53

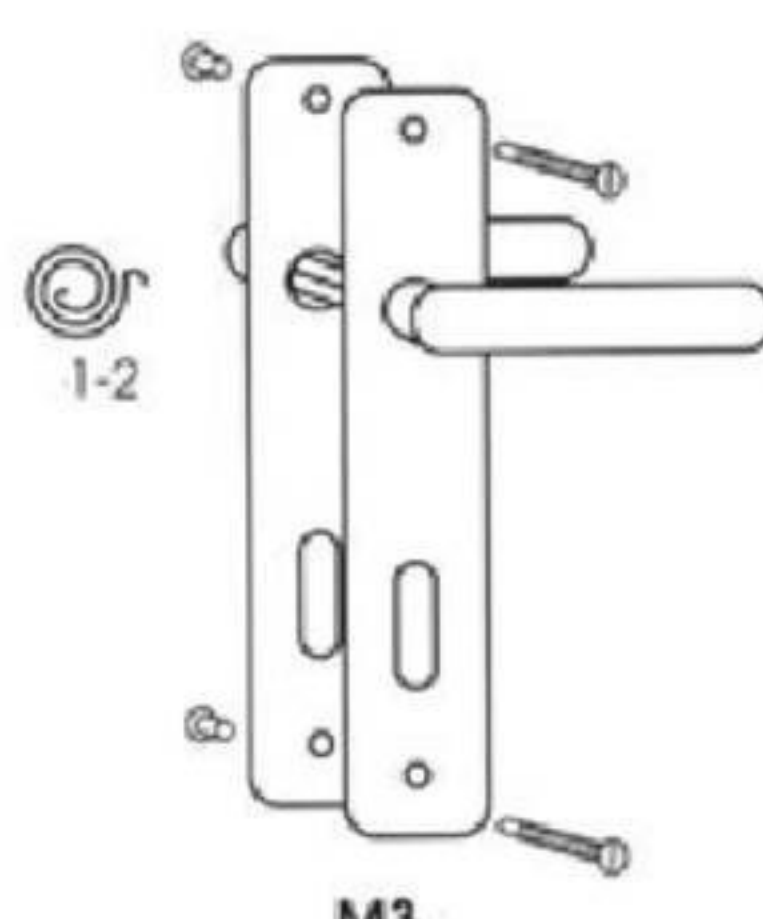

M3

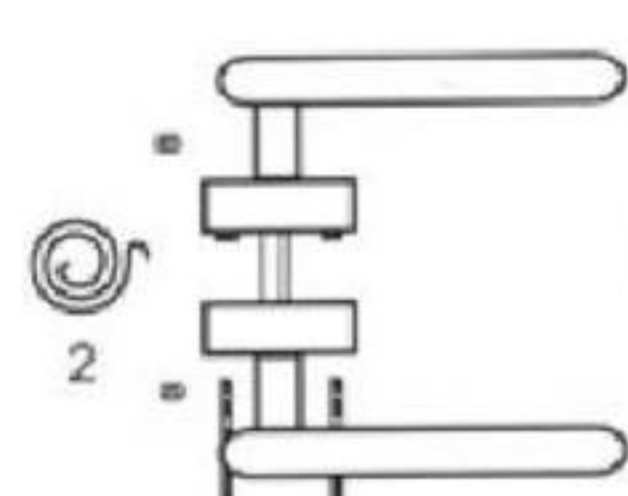

M7

Rosetta coprivite D 38-Ø53

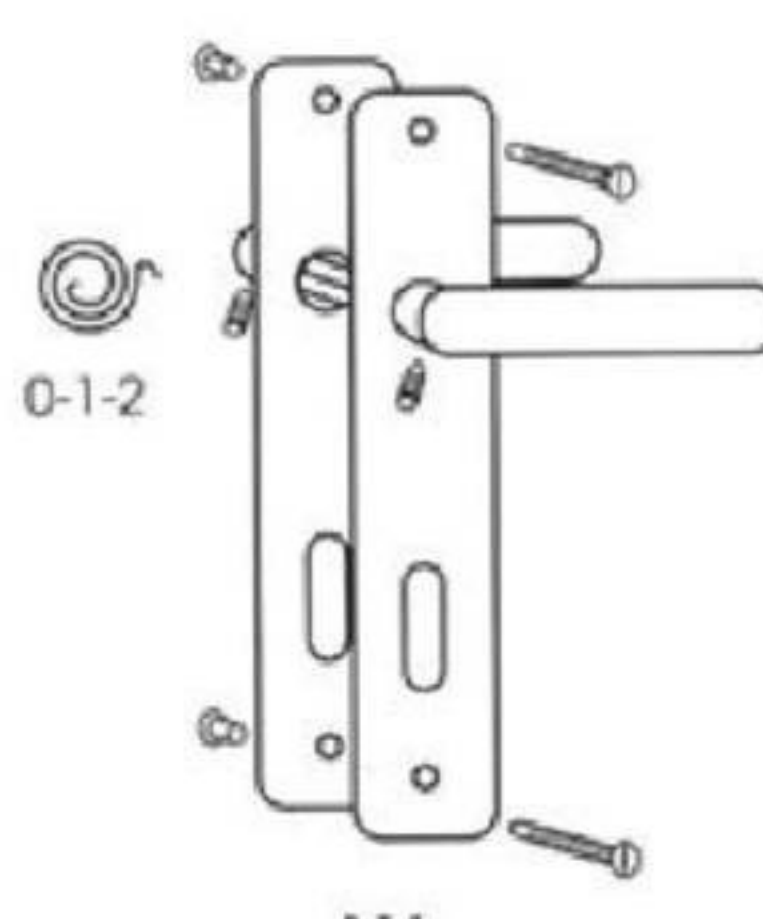

M4

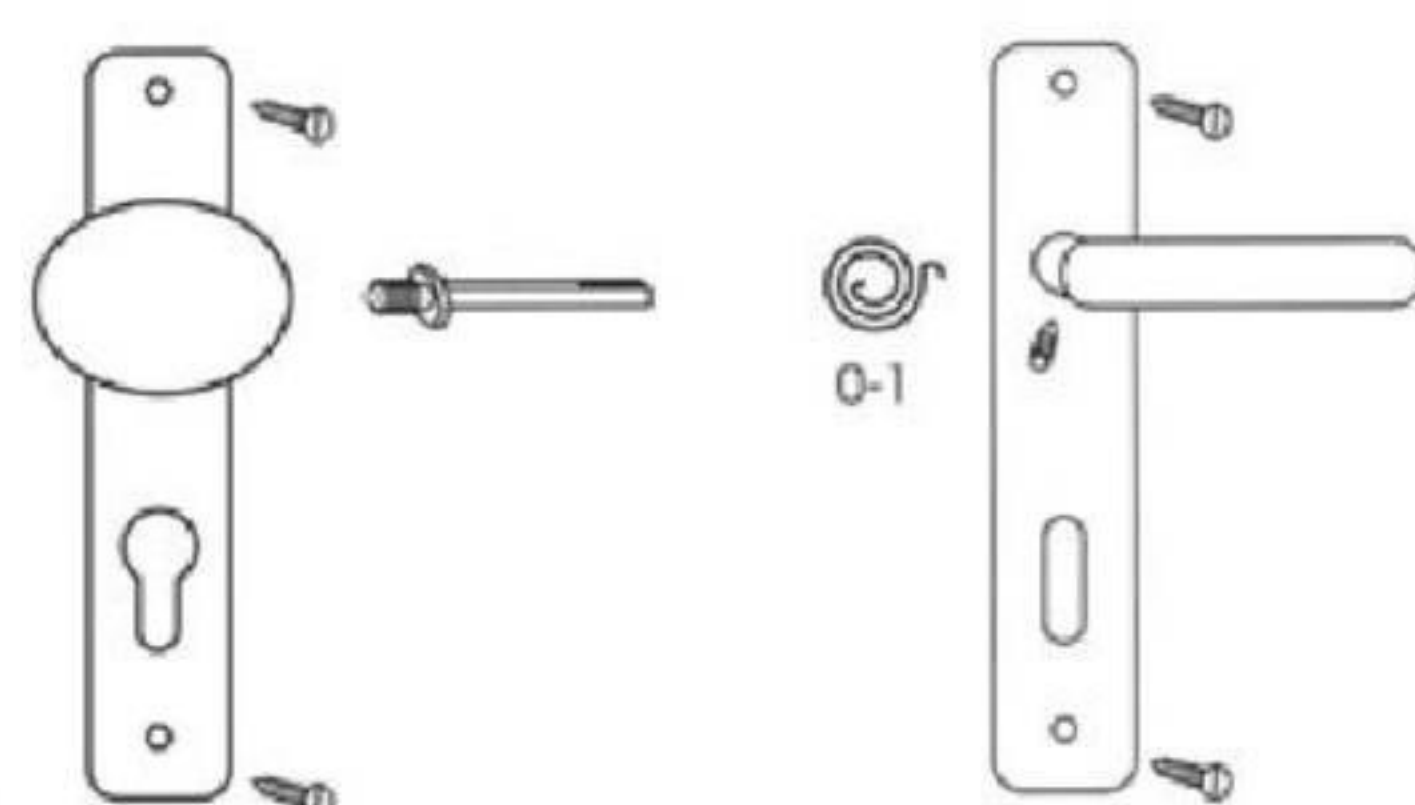

M9

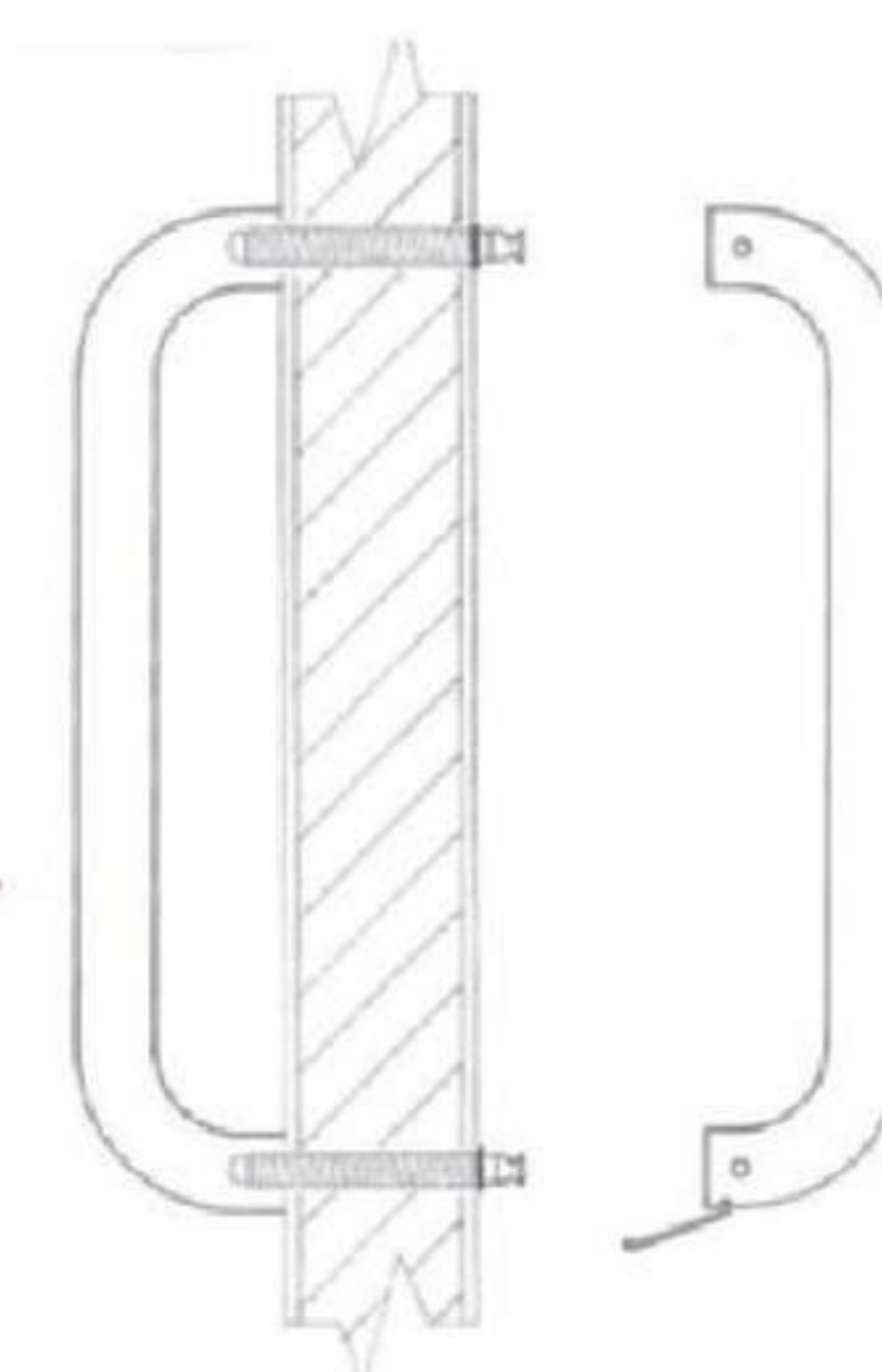

Maniglioni accoppiati

SERRATURA DA INFILARE CON CILINDRO



CODICE	L (MM)	A (MM)	B (CHIUSURE)
10.85.40	85	40	67
10.85.45	85	50	72
10.90.40	90	40	67
10.90.45	90	45	72

SERRATURA DA INFILARE PATENT



CODICE	L (MM)	A (MM)	B (CHIUSURE)
10.72.40	72	40	67
10.85.40	85	40	67
10.90.40	90	40	67
10.90.45	90	45	72

SERRATURA DA INFILARE PER BAGNO

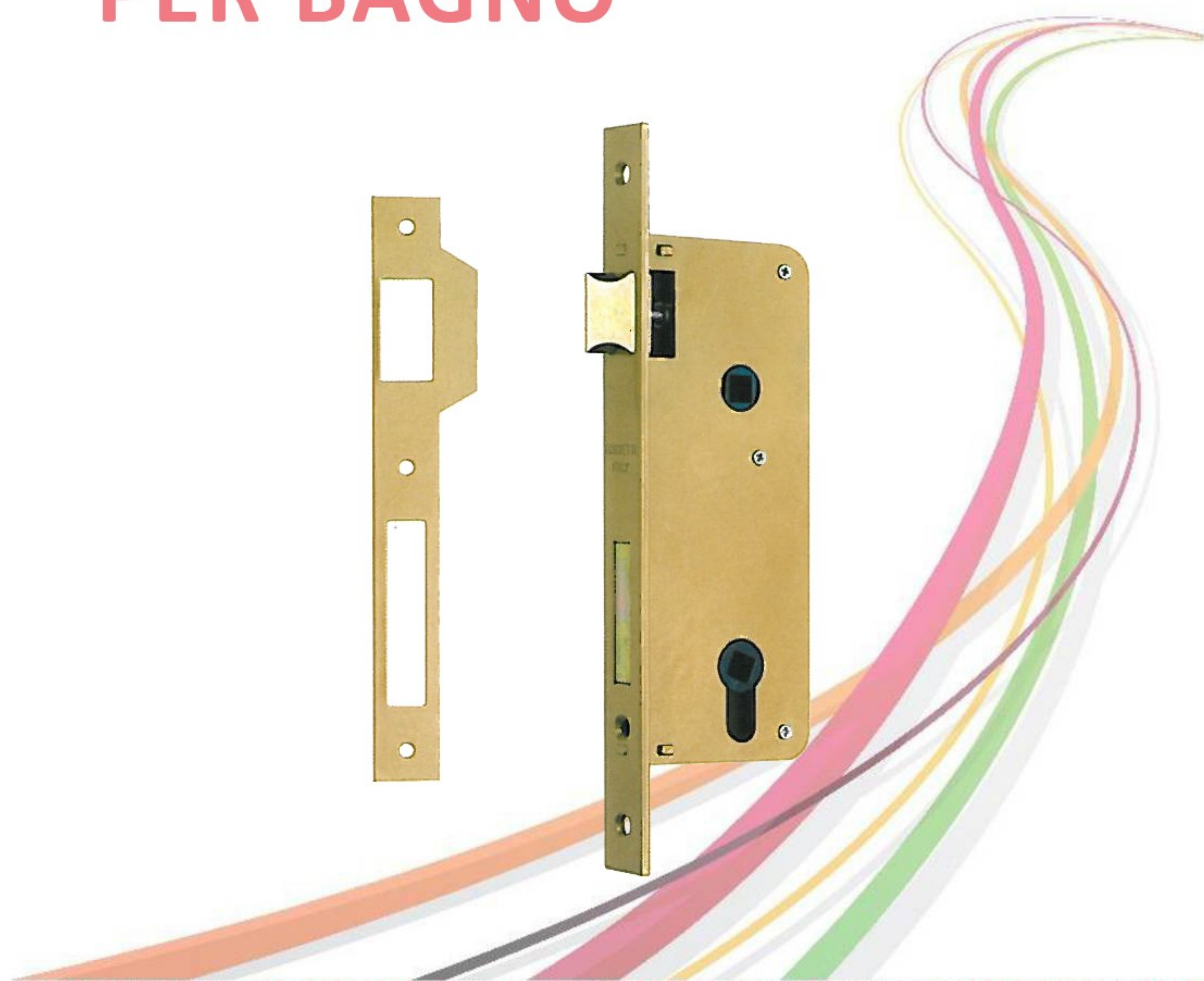

CODICE	L (MM)	A (MM)	B (CHIUSURE)
12.85.40	85	40	67
12.85.45	85	45	72
12.90.40	90	40	67
12.90.45	90	45	72

SERRATURA DA INFILARE CON CILINDRO - SCATOLA APERTA



CODICE	L (MM)	A (MM)	B (CHIUSURE)
10.85.40	85	40	67
10.85.50	85	50	77

SERRATURA DA INFILARE PATENT - SCATOLA APERTA

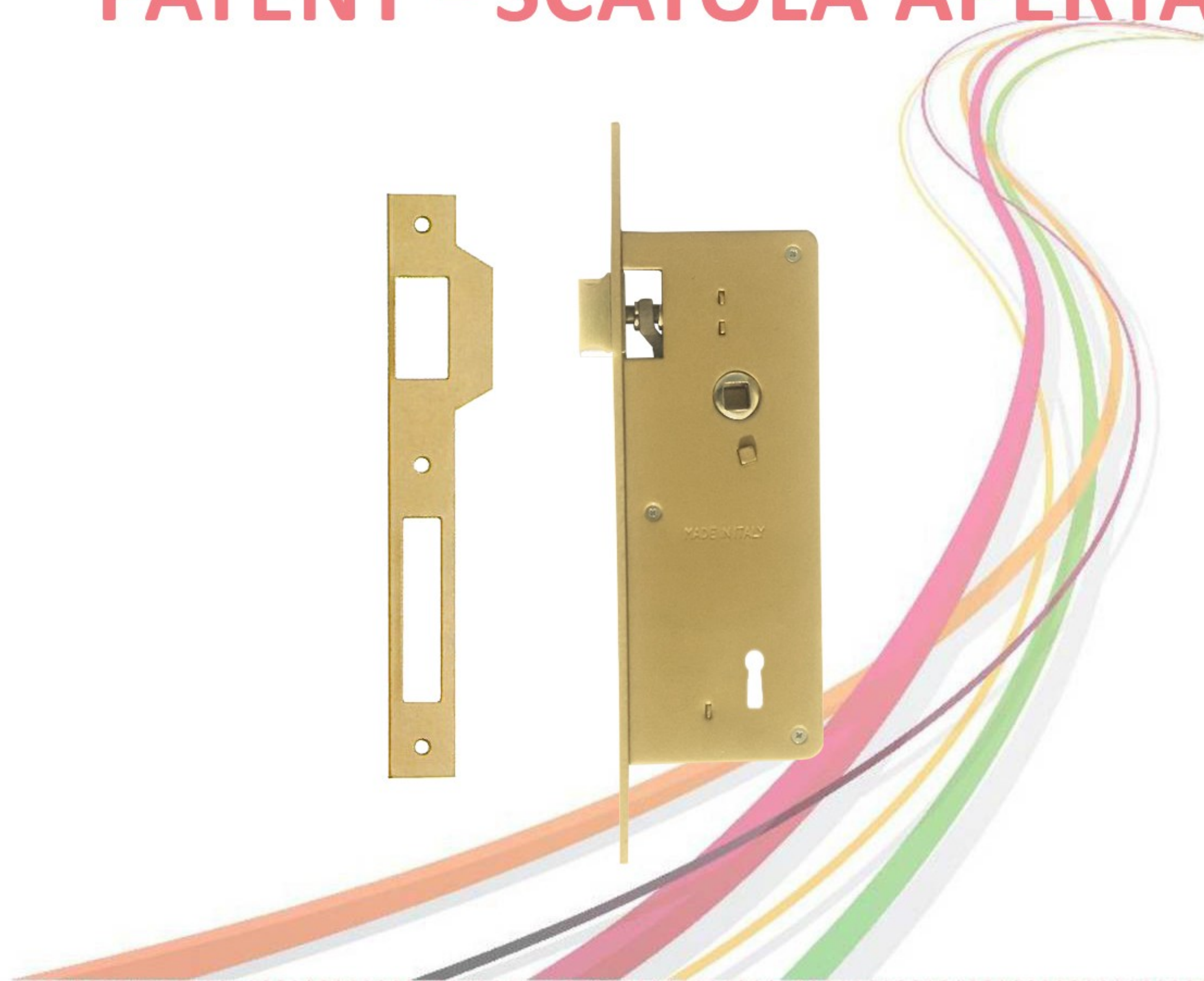

CODICE	L (MM)	A (MM)	B (CHIUSURE)
10.72.40	72	40	67
10.85.40	85	40	67

SERRATURA DA INFILARE CON CILINDRO - SCATOLA CHIUSA



CODICE	L (MM)	A (MM)	B (CHIUSURE)
10.85.40	85	40	67
10.90.40	90	40	67

SERRATURA DA INFILARE CON CILINDRO - SCATOLA CHIUSA



CODICE	L (MM)	A (MM)	B (CHIUSURE)
10.85.45	85	45	72
10.90.45	90	45	72

SERRATURA DI SICUREZZA DA APPLICARE CON CILINDRO FISSO - SCROCCO



CODICE	A (MM)	B (MM)	G (CHIUSURE)
23.50	50	100	2
23.60	60	120	3
23.70	70	140	3

SERRATURA DI SICUREZZA DA APPLICARE CON CILINDRO FISSO - 3 PISTONI



CODICE	A (MM)	B (MM)	G (CHIUSURE)
23.50	50	100	1
23.60	60	120	2
23.70	70	140	2

SERRATURE IN ALLUMINIO



CODICE	A (MM)	B (MM)	G (CHIUSURE)
14.70.70	70	70	167

CILINDRO IN OTTONE CON 3 CHIAVI

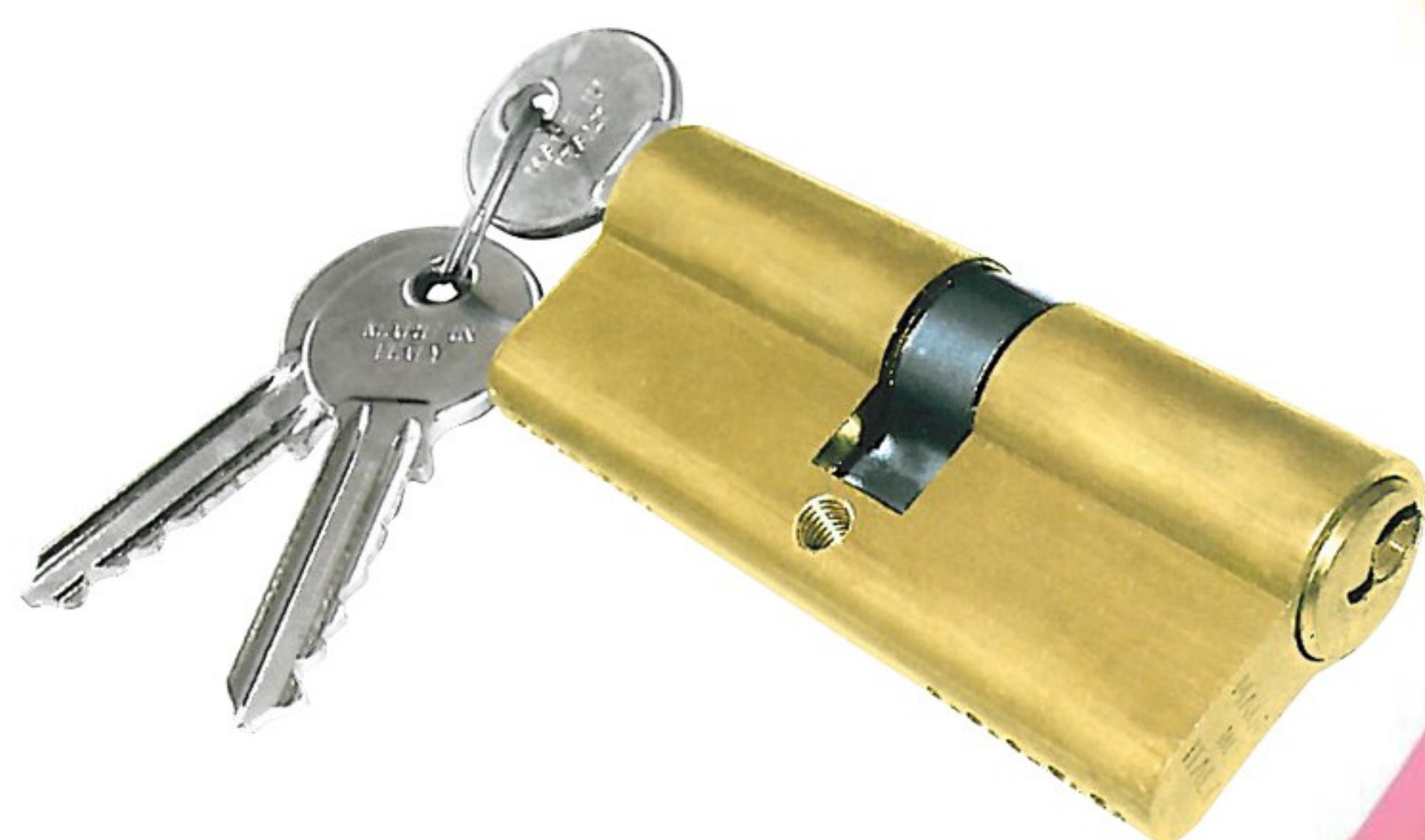

CODICE	L(MM)	A(MM)	B(MM)	CODICE	L(MM)	A(MM)	B(MM)
50.60.30	60	30	30	50.80.35	80	35	45
50.65.30	65	30	35	50.85.40	85	40	45
50.70.35	70	35	35	50.85.35	85	35	50
50.70.30	70	30	40	50.90.45	90	45	45
50.75.35	75	35	40	50.90.35	90	35	55
50.75.30	75	30	45	50.95.40	95	40	55
50.80.40	80	40	40	50.95.45	95	45	50
50.80.30	80	30	50	50.107.47	107	45	62

CILINDRO IN OTTONE CON 3 CHIAVI



CODICE	L(MM)	A(MM)	B(MM)	CODICE	L(MM)	A(MM)	B(MM)
50.60.30	60	30	30	50.80.35	80	35	45
50.65.30	65	30	35	50.85.40	85	40	45
50.70.35	70	35	35	50.85.35	85	35	50
50.70.30	70	30	40	50.90.45	90	45	45
50.75.35	75	35	40	50.90.35	90	35	55
50.75.30	75	30	45	50.95.40	95	40	55
50.80.40	80	40	40	50.95.45	95	45	50
50.80.30	80	30	50	50.107.47	107	45	62

CILINDRO SAGOMATO AD ALTA SICUREZZA IN OTTONE CON 5 CHIAVI



CODICE	L(MM)	A(MM)	B(MM)
51.60.30	60	30	30
51.65.30	65	30	35
51.70.35	70	35	35
51.75.35	75	35	40

CILINDRO CON POMOLO CON 3 CHIAVI



CODICE	L(MM)	A(MM)	B(MM)	CODICE	L(MM)	A(MM)	B(MM)
52.60.30	60	30	30	52.85.30	85	30	55
52.65.30	60	30	35	52.85.35	85	35	50
52.70.35	70	35	35	52.85.45	85	45	40
52.70.30	70	30	40	52.90.30	90	30	60
52.70.40	70	40	30	52.90.35	90	35	55
52.80.40	80	40	40	52.90.40	90	40	50
52.80.30	80	30	50	52.90.45	90	45	45
52.80.50	80	50	30				
52.80.35	80	35	45				
52.80.45	80	45	35				

